



**THE DISPLAY CHOICE
OF PROFESSIONALS™**

IFP-6503, IFP-7503 & IFP-8603 4K UHD Interactive Display

www.agneovo.com

User Manual

TABLE OF CONTENTS

SAFETY INFORMATION	1
Federal Communications Commission (FCC) Notice (U.S. Only).....	1
Polish Center for Testing and Certification Notice	1
Electric, Magnetic and Electromagnetic Fields ("EMF").....	2
Information for U.K. only.....	3
North Europe (Nordic Countries) Information.....	4
End-of-Life Disposal	5
Waste Electrical and Electronic Equipment-WEEE.....	5
Turkey RoHS.....	6
Ukraine RoHS	6
PRECAUTIONS	7
Cautions When Setting Up	7
Cautions When Using.....	8
Cleaning and Maintenance.....	8
Notice for the Interactive Display.....	9
Caring for the Touch Screen.....	9
CHAPTER 1: PRODUCT DESCRIPTION.....	10
1.1 Unpacking	10
1.2 Package Contents	10
1.3 Preparing for the Installation	11
1.4 Wall Mounting Installation.....	11
1.4.1 VESA Grid	12
1.4.2 Mounting the Interactive Display on the Wall.....	12
1.4.3 Ventilation Requirements for Enclosure Locating	14
1.5 Mounting the Interactive Display on the Stand.....	15
1.6 Installing the Wi-Fi Module	20
1.7 Interactive Display Overview.....	21
1.7.1 Control Panel.....	21
1.7.2 Input/Output Terminals	22
1.8 Remote Control	24
1.8.1 General Functions	24
1.8.2 Inserting the Batteries in the Remote Control	26
1.8.3 Handling the Remote Control	26
1.8.4 Operating Range of the Remote Control.....	27
CHAPTER 2: MAKING CONNECTIONS.....	28
2.1 Connecting the Power	28
2.2 Connecting a Computer or Portable Device.....	29
2.2.1 Using VGA (D-Sub) Input	29
2.2.2 Using RS232 Input	30
2.2.3 Using HDMI Input.....	30
2.2.4 Using the Touch Module.....	31
2.3 Connecting External Equipment (Video Player).....	33
2.4 Connecting a Display Device	34

TABLE OF CONTENTS

2.5 Connecting to a Wired Network.....	35
2.6 Connecting Audio Equipment.....	36
2.7 Connecting USB Interface Devices.....	37
2.8 Attaching Touch Pens.....	37
CHAPTER 3: USING THE INTERACTIVE DISPLAY.....	38
3.1 Turning on the Power.....	38
3.2 Selecting the Input Source Signal.....	38
3.3 Adjusting the Volume.....	39
3.4 Using Freeze Function.....	39
3.5 Android Functions.....	40
3.5.1 Accessing the Home Screen.....	40
3.5.2 Returning to the Previous Screen.....	40
3.5.3 Blanking the Screen.....	41
3.5.4 Activating the Writing Mode.....	41
3.6 Using the Touchscreen.....	42
3.7 Using the On-Screen Keyboard.....	46
CHAPTER 4: USING THE SYSTEM.....	47
4.1 About the Home Screen.....	47
4.2 Using the Assistive Menu.....	48
4.3 On Screen Display (OSD) Menu.....	50
4.3.1 OSD Menu Tree.....	51
4.4 Adjusting the Interactive Display.....	52
4.4.1 Audio Menu.....	52
4.4.2 Screen Menu.....	53
4.4.3 Display Menu.....	55
4.4.4 Adjust Menu.....	56
4.5 Configuring System Settings.....	57
4.6 Power Settings.....	59
4.6.1 Booting Options.....	59
4.6.2 Scheduling.....	60
CHAPTER 5: USING THE APPS.....	61
5.1 Accessing Apps.....	61
5.2 Meetboard Apps.....	62
5.3 Annotation Tool.....	66
5.4 Finder App.....	66
5.5 Cloud Drive.....	67
5.6 Bytello Share App.....	68
CHAPTER 6: APPENDIX.....	71
6.1 Warning Messages.....	71
6.2 Supported Media Formats.....	71
6.3 Supported Resolution.....	74
6.4 Troubleshooting.....	76
6.5 Transporting the Interactive Display.....	77

TABLE OF CONTENTS

CHAPTER 7: SPECIFICATIONS	79
7.1 Display Specifications	79
7.2 Display Dimensions	80

SAFETY INFORMATION

Federal Communications Commission (FCC) Notice (U.S. Only)



This equipment has been tested and found to comply with the limits for a Class B digital device, pursuant to part 15 of the FCC Rules. These limits are designed to provide reasonable protection against harmful interference in a residential installation. This equipment generates, uses and can radiate radio frequency energy and, if not installed and used in accordance with the instructions, may cause harmful interference to radio communications. However, there is no guarantee that interference will not occur in a particular installation. If this equipment does cause harmful interference to radio or television reception, which can be determined by turning the equipment off and on, the user is encouraged to try to correct the interference by one or more of the following measures:

- Reorient or relocate the receiving antenna.
- Increase the separation between the equipment and receiver.
- Connect the equipment into an outlet on a circuit different from that to which the receiver is connected.
- Consult the dealer or an experienced radio/TV technician for help.



Changes or modifications not expressly approved by the party responsible for compliance could void the user's authority to operate the equipment.

Use only an RF shielded cable that was supplied with the display when connecting this display to a computer device.

To prevent damage which may result in fire or shock hazard, do not expose this appliance to rain or excessive moisture.

THIS CLASS B DIGITAL APPARATUS MEETS ALL REQUIREMENTS OF THE CANADIAN INTERFERENCE-CAUSING EQUIPMENT REGULATIONS.



This device complies with Part 15 of the FCC Rules. Operation is subject to the following two conditions: (1) this device may not cause harmful interference, and (2) this device must accept any interference received, including interference that may cause undesired operation.

Polish Center for Testing and Certification Notice

The equipment should draw power from a socket with an attached protection circuit (a three-prong socket). All equipment that works together (computer, display, printer, and so on) should have the same power supply source.

The phasing conductor of the room's electrical installation should have a reserve short-circuit protection device in the form of a fuse with a nominal value no larger than 16 amperes (A).

To completely switch off the equipment, the power supply cable must be removed from the power supply socket, which should be located near the equipment and easily accessible.

A protection mark "B" confirms that the equipment is in compliance with the protection usage requirements of standards PN-93/T-42107 and PN-89/E-06251.

SAFETY INFORMATION

Wymagania Polskiego Centrum Badań i Certyfikacji

Urządzenie powinno być zasilane z gniazda z przyłączonym obwodem ochronnym (gniazdo z kołkiem). Współpracujące ze sobą urządzenia (komputer, monitor, drukarka) powinny być zasilane z tego samego źródła.

Instalacja elektryczna pomieszczenia powinna zawierać w przewodzie fazowym rezerwową ochronę przed zwarciami, w postaci bezpiecznika o wartości znamionowej nie większej niż 16A (amperów).

W celu całkowitego wyłączenia urządzenia z sieci zasilania, należy wyjąć wtyczkę kabla zasilającego z gniazdka, które powinno znajdować się w pobliżu urządzenia i być łatwo dostępne.

Znak bezpieczeństwa "B" potwierdza zgodność urządzenia z wymaganiami bezpieczeństwa użytkownika zawartymi w PN-93/T-42107 i PN-89/E-06251.

Pozostałe instrukcje bezpieczeństwa

- Nie należy używać wtyczek adapterowych lub usuwać kołka obwodu ochronnego z wtyczki. Jeżeli konieczne jest użycie przedłużacza to należy użyć przedłużacza 3-fazowego z prawidłowo przyłączonym przewodem ochronnym.
- System komputerowy należy zabezpieczyć przed nagłymi, chwilowymi wzrostami lub spadkami napięcia, używając eliminatora przepięcia, urządzenia dopasowującego lub bezakceptancyjnego źródła zasilania.
- Należy upewnić się, aby nic nie leżało na kablach systemu komputerowego, oraz aby kable nie były umieszczone w miejscu, gdzie mogą być nadeptywane lub potykać się o nie.
- Nie należy rozlewać napojów ani innych płynów na system komputerowy.
- Nie należy wpychać żadnych przedmiotów do otworów systemu komputerowego, gdyż może to spowodować pożar lub porażenie prądem, poprzez zwarcie elementów wewnętrznych.
- System komputerowy powinien znajdować się z dala od grzejników i źródeł ciepła. Ponadto, nie należy blokować otworów wentylacyjnych. Należy unikać kładzenia luźnych papierów pod komputer oraz umieszczania komputera w ciasnym miejscu bez możliwości cyrkulacji powietrza wokół niego.

Electric, Magnetic and Electromagnetic Fields ("EMF")

- We manufacture and sell many products targeted at consumers, which, like any electronic apparatus, in general have the ability to emit and receive electromagnetic signals.
- One of our leading Business Principles is to take all necessary health and safety measures for our products, to comply with all applicable legal requirements and to stay well within the EMF standards applicable at the time of producing the products.
- We are committed to develop, produce and market products that cause no adverse health effects.
- We confirm that if its products are handled properly for their intended use, they are safe to use according to scientific evidence available today.
- We play an active role in the development of international EMF and safety standards, enabling us to anticipate further developments in standardization for early integration in its products.

SAFETY INFORMATION

Information for U.K. only

WARNING - THIS APPLIANCE MUST BE EARTHED.

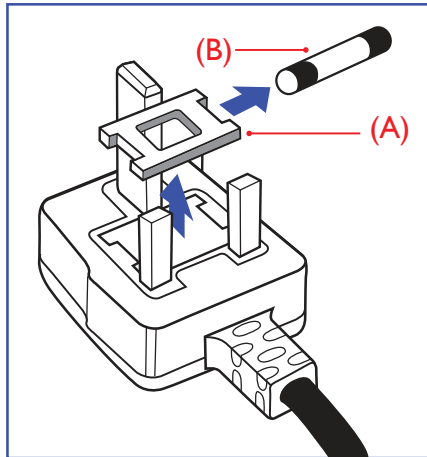

Important:

This apparatus is supplied with an approved moulded 13A plug. To change a fuse in this type of plug proceed as follows:

- 1 Remove fuse cover and fuse.
- 2 Fit new fuse which should be a BS 1362 5A, A.S.T.A. or BSI approved type.
- 3 Refit the fuse cover.

If the fitted plug is not suitable for your socket outlets, it should be cut off and an appropriate 3-pin plug fitted in its place.

If the mains plug contains a fuse, this should have a value of 5A. If a plug without a fuse is used, the fuse at the distribution board should not be greater than 5A.



Note:

The severed plug must be destroyed to avoid a possible shock hazard should it be inserted into a 13A socket elsewhere.

SAFETY INFORMATION

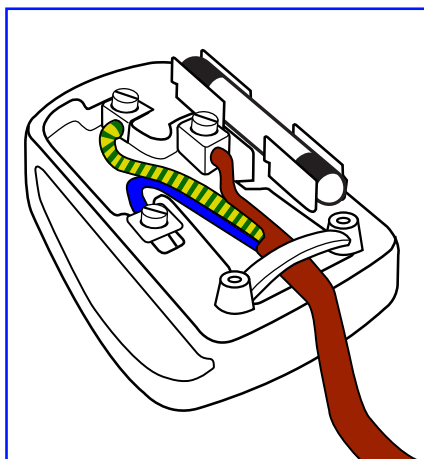

How to connect a plug

The wires in the mains lead are coloured in accordance with the following code:

BLUE - "NEUTRAL" ("N")

BROWN - "LIVE" ("L")

GREEN & YELLOW - "EARTH" ("E")

- The GREEN & YELLOW wire must be connected to the terminal in the plug which is marked with the letter "E" or by the Earth symbol or coloured GREEN or GREEN & YELLOW.
- The BLUE wire must be connected to the terminal which is marked with the letter "N" or coloured BLACK.
- The BROWN wire must be connected to the terminal which marked with the letter "L" or coloured RED.

Before replacing the plug cover, make certain that the cord grip is clamped over the sheath of the lead - not simply over the three wires.

North Europe (Nordic Countries) Information

Placering/Ventilation

WARNING: FÖRSÄKRA DIG OM ATT HUVUDBRYTARE OCH UTTAG ÄR LÄTÅTKOMLIGA, NÄR DU STÄLLER DIN UTRUSTNING PÅPLATS.

Placering/Ventilation

ADVARSEL: SØRG VED PLACERINGEN FOR, AT NETLEDNINGENS STIK OG STIKKONTAKT ER NEMT TILGÆNGLIGE.

Paikka/Ilmankierto

VAROITUS: SIJOITA LAITE SITEN, ETTÄ VERKKOJOHTO VOIDAAN TARVITTAESSA HELPOSTI IRROTTAA PISTORASIESTA.

Plassering/Ventilasjon

ADVARSEL: NÅR DETTE UTSTYRET PLASSERES, MÅ DU PASSE PÅ AT KONTAKTENE FOR STØMTILFØRSEL ER LETTE Å NÅ.

SAFETY INFORMATION

End-of-Life Disposal

Your new Public Information Display contains materials that can be recycled and reused. Specialized companies can recycle your product to increase the amount of reusable materials and to minimize the amount to be disposed of.

Please find out about the local regulations on how to dispose of your old display from your local dealer.

(For customers in Canada and U.S.A.)

This product may contain lead and/or mercury. Dispose of in accordance to local-state and federal regulations. For additional information on recycling contact www.eia.org (Consumer Education Initiative).

Waste Electrical and Electronic Equipment-WEEE

Attention users in European Union private households



Disposal of Waste Equipment by Users in Private Household in the European Union.

This symbol on the product or on its packaging indicates that this product must not be disposed of with your other household waste. Instead, it is your responsibility to dispose of your waste equipment by handing it over to a designated collection point for the recycling of waste electrical and electronic equipment. The separate collection and recycling of your waste equipment at the time of disposal will help to conserve natural resources and ensure that it is recycled in a manner that protects human health and the environment. For more information about where you can drop off your waste equipment for recycling, please contact your local city office, your household waste disposal service or the shop where you purchased the product.

For Private Households in the European Union. To help conserve natural resources and ensure the product is recycled in a manner that protects human health and the environment, we would like to bring your attention to the following:

- The crossed-out dustbin on the device or outer packaging indicates the product is compliant with European WEEE (Waste Electrical and Electronic Equipment) Directive
- Always dispose of the old devices separately from household waste
- Batteries should be removed beforehand and disposed separately to the right collection system
- You are responsible with regard to the deletion of personal data on old devices before disposal
- Private households can hand in their old devices free of charge
- For more information about where you can drop off your waste equipment for recycling, please contact your local city office, your household waste disposal service or the shop where you purchased the product

Attention users in United States:

Please dispose of according to all Local, State and Federal Laws. For the disposal or recycling information, contact: www.mygreenelectronics.com or www.eiae.org.

End of Life Directives-Recycling



Your new Public Information Display contains several materials that can be recycled for new users.

Please dispose of according to all Local, State, and Federal laws.

SAFETY INFORMATION

Restriction on Hazardous Substances statement (India)

This product complies with the “India E-waste Rule 2011” and prohibits use of lead, mercury, hexavalent chromium, polybrominated biphenyls or polybrominated diphenyl ethers in concentrations exceeding 0.1 weight % and 0.01 weight % for cadmium, except for the exemptions set in Schedule 2 of the Rule.

E-Waste Declaration for India



This symbol on the product or on its packaging indicates that this product must not be disposed of with your other household waste. Instead it is your responsibility to dispose of your waste equipment by handing it over to a designated collection point for the recycling of waste electrical and electronic equipment. The separate collection and recycling of your waste equipment at the time of disposal will help to conserve natural resources and ensure that it is recycled in a manner that protects human health and the environment.

Batteries



For EU: The crossed-out wheeled bin implies that used batteries should not be put to the general household waste! There is a separate collection system for used batteries, to allow proper treatment and recycling in accordance with legislation.

Please contact your local authority for details on the collection and recycling schemes.

For Switzerland: The used battery is to be returned to the selling point.

For other non-EU countries: Please contact your local authority for correct method of disposal of the used battery.

According to EU directive 2006/66/EC, the battery can't be disposed improperly. The battery shall be separated to collect by local service.

Turkey RoHS

Türkiye Cumhuriyeti: EEE Yönetmeliğine Uygundur.

Ukraine RoHS

Обладнання відповідає вимогам Технічного регламенту щодо обмеження використання деяких небезпечних речовин в електричному та електронному обладнанні, затвердженого постановою Кабінету Міністрів України від 3 грудня 2008 № 1057.

PRECAUTIONS

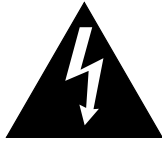

Symbols used in this manual

	This icon indicates the existence of a potential hazard that could result in personal injury or damage to the product.
	This icon indicates important operating and servicing information.

Notice

- Read this User Manual carefully before using the interactive display and keep it for future reference.
- The product specifications and other information provided in this User Manual are for reference only. All information is subject to change without notice. Updated content can be downloaded from our web site at www.agneovo.com.
- To protect your rights as a consumer, do not remove any stickers from the interactive display. Doing so may affect the determination of the warranty period.

Cautions When Setting Up

- Do not place the interactive display near heat sources, such as a heater, exhaust vent, or in direct sunlight.
- Do not cover or block the ventilation holes in the housing.
- Place the interactive display on a stable area. Do not place the interactive display where it may subject to vibration or shock.
- Place the interactive display in a well-ventilated area.
- Do not place the interactive display outdoors.
- To avoid the risk of shock or permanent damage to the set, do not expose the display to dust, rain, water or an excessively moist environment.
- Do not spill liquid or insert sharp objects into the interactive display through the ventilation holes. Doing so may cause accidental fire, electric shock or damage the interactive display.

PRECAUTIONS

Cautions When Using

- Use only the power cord supplied with the interactive display.
- The power outlet should be installed near the interactive display and be easily accessible.
- If an extension cord is used with the interactive display, ensure that the total current consumption plugged into the power outlet does not exceed the ampere rating.
- Do not allow anything to rest on the power cord. Do not place the interactive display where the power cord may be stepped on.
- If the interactive display will not be used for an indefinite period of time, unplug the power cord from the power outlet.
- To disconnect the power cord, grasp and pull by the plug head. Do not tug on the cord; doing so may cause fire or electric shock.
- Do not unplug or touch the power cord with wet hands.
- When turning off the display by detaching the power cord, wait 6 seconds before re-attaching the power cord for normal operation.
- Do not knock or drop the display during operation or transportation.

Cleaning and Maintenance

- To protect your display from possible damage, do not put excessive pressure on the LCD panel. When moving your display, grasp the frame to lift; do not lift the display by placing your hand or fingers on the LCD panel.
- For cleaning the touch screen, refer to page 9.
- If your display becomes wet, wipe it with dry cloth as soon as possible.
- If a foreign substance or water gets in your display, turn the power off immediately and disconnect the power cord. Then remove the foreign substance or water, and send the unit to the maintenance center.
- In order to maintain the best performance of your display and ensure a longer lifetime, we strongly recommend using the display in a location that falls within the following temperature and humidity ranges.
 - ◆ Temperature: 0°C-40°C (32°F-104°F)
 - ◆ Humidity: 10%-90% (non-condensing)



Warning:



Unplug the power cord from the power outlet and refer to qualified service

personnel under the following conditions:

- ◆ When the power cord is damaged.
- ◆ If the interactive display has been dropped or the housing has been damaged.
- ◆ If the interactive display emits smoke or a distinct odor.

PRECAUTIONS

Notice for the Interactive Display

- In order to maintain the stable luminous performance, it is recommended to use low brightness setting.
- Due to the lifespan of the lamp, it is normal that the brightness quality of the interactive display may decrease with time.
- When static images are displayed for long periods of time, the image may cause an imprint on the interactive display. This is called image retention or burn-in.
 - ◆ To prevent image retention, do any of the following:
 - Set the interactive display to turn off after a few minutes of being idle.
 - Use a screen saver that has moving graphics or a blank white image.
 - Switch desktop backgrounds regularly.
 - Adjust the interactive display to low brightness settings.
 - Turn off the interactive display when the system is not in use.
 - ◆ Things to do when the interactive display shows image retention:
 - Turn off the interactive display for extended periods of time. It can be several hours or several days.
 - Use a screen saver and run it for extended periods of time.
 - Use a black and white image and run it for extended periods of time.
- There are millions of micro transistors inside the interactive display. It is normal for a few transistors to be damaged and to produce spots. This is acceptable and is not considered a failure.
- **IMPORTANT:** Always activate a moving screen saver program when you leave your display unattended. Always activate a periodic screen refresh application if the unit will display unchanging static content. Uninterrupted display of still or static images over an extended period may cause “burn in”, also known as “after-imaging” or “ghost imaging”, on your screen. This is a well-known phenomenon in LCD panel technology. In most cases, the “burned in” or “after-imaging” or “ghost imaging” will disappear gradually over a period of time after the power has been switched off.
- **WARNING:** Severe “burn-in” or “after-image” or “ghost image” symptoms will not disappear and cannot be repaired. This is also not covered under the terms of your warranty.

Caring for the Touch Screen

Use the following recommendations to care for the touch screen.

- Before cleaning the screen, make sure the interactive display is switched off and the power cord is unplugged from the wall outlet.
- Remove dirt or dust from the screen regularly. It is recommended to use a small amount of alcohol as cleaning agent.
- To avoid damage to the screen, never use any aggressive solvents or scrubbing agents.
- Wipe the screen gently using a lint-free cloth moistened in the cleaning agent.
- Never spray the cleaning agent on the screen surface or the body directly as it may cause short circuit to the touch screen.
- Do not expose the display to direct sunlight or strong light source during use.

CHAPTER 1: PRODUCT DESCRIPTION

1.1 Unpacking

- This product is packed in a packaging box which contains standard accessories.
- Any other optional accessories will be packed separately.
- Considering the size and weight of the display, it is recommended that this product is carried out by two persons.
- After opening the packaging box, ensure that the included items are in good condition and complete.

1.2 Package Contents

When unpacking, check if the following items are included in the package. If any of them is missing or damaged, contact your dealer.

Interactive Display



Remote Control

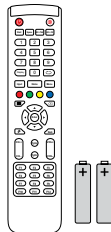

Quick Start Guide



HDMI Cable

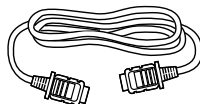

**USB Cable
(for touch control)**

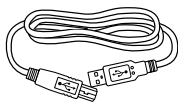

Power Cord

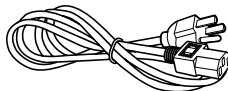

Touch Pen x 2



Wi-Fi Module



Wall Mount

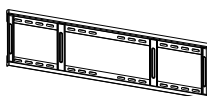

**Wall Mount Screw
Package**

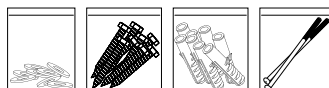

Note:

- ◆ Remote control is shipped with the supplied AAA batteries.
- ◆ For all other regions, apply a power cord that conforms to the AC voltage of the power socket and has been approved by and complies with the safety regulations of the particular country (Type H05W-F, 2G or 3G, 0.75 or 1 mm² should be used).
- ◆ You might like to save the package box and packing material for shipping the display.
- ◆ The pictures are for reference only. Actual items may vary upon shipment.

PRODUCT DESCRIPTION

1.3 Preparing for the Installation

- Due to the high power consumption, always use the plug exclusively designed for this product. If an extended line is required, please consult your service agent.
- The product should be installed on a flat surface to avoid tipping. The distance between the back of the product and the wall should be maintained for proper ventilation. Avoid installing the product in the kitchen, bathroom or any other places with high humidity so as not to shorten the service life of the electronic components.
- The product can normally operate only under 3600m in altitude. In installations at altitudes above 3600m, some abnormalities may be experienced.

1.4 Wall Mounting Installation

To mount this display to a wall, you will have to obtain a standard wall-mounting kit (commercially available). We recommend using a mounting interface that complies with TUV-GS and/or UL1678 standard in North America.

To wall-mount the interactive display, screw the mounting bracket to the VESA holes at the rear of the interactive display.

IFP-6503

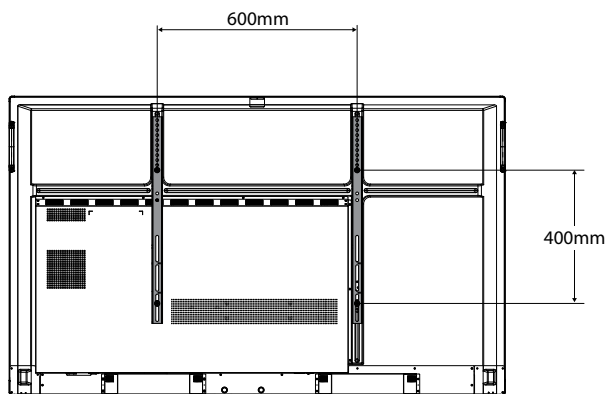

IFP-7503

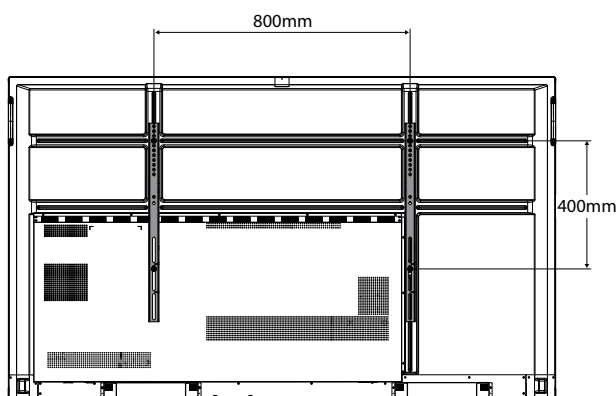

Warning:

- ◆ Do not press too hard on the LCD panel or edge of the frame, as this may cause the device to malfunction.

Note:

- ◆ Avoid the wall-mounting kit to block the ventilation holes on the back of the display.
- ◆ Secure the interactive display on a solid wall strong enough to bear its weight.
- ◆ Lay a protective sheet on a table, which was wrapped around the display when it was packaged, beneath the screen surface so as not to scratch the screen face.
- ◆ Ensure you have all accessories for mounting this display (wall mount, ceiling mount, etc).
- ◆ Follow the instructions that come with the base mounting kit. Failure to follow correct mounting procedures could result in damage to the equipment or injury to the user or installer. Product warranty does not cover damage caused by improper installation.

PRODUCT DESCRIPTION

IFP-8603

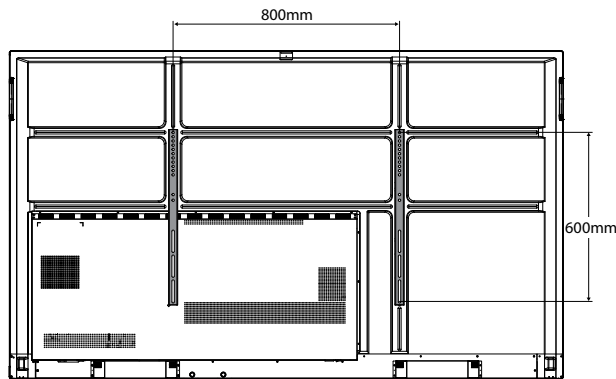

1.4.1 VESA Grid

Model Name	VESA Grid
IFP-6503	600(W) x 400(H)mm
IFP-7503	800(W) x 400(H)mm
IFP-8603	800(W) x 600(H)mm

Caution:

To prevent the display from falling:

- ◆ For wall or ceiling installation, we recommend installing the display with metal brackets which are commercially available. For detailed installation instructions, see the guide received with the respective bracket.
- ◆ To lessen the probability of injury and damage resulting from fall of the display in case of earthquake or other natural disaster, be sure to consult the bracket manufacturer for installation location.

1.4.2 Mounting the Interactive Display on the Wall

To mount the interactive display on the wall, you need the following items:

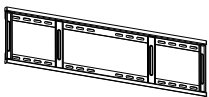

Wall Mount x 1



Washers
x 8

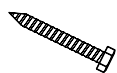

Screws
x 8



Plastic
Anchors x 8



Screws
x 2

Note:

- ◆ For the wall-mounting kit, use M6 mounting screws (having a length 10 mm longer than the thickness of the mounting bracket) and tighten them securely.
- ◆ Unit without base weight:
IFP-6503=39.4 kg /
IFP-7503=50.9 kg /
IFP-8603=66.0 kg.
The equipment and its associated mounting means still remain secure during the test. For use only with UL Listed Wall Mount Bracket with minimum weight/load:
IFP-6503=48.8 kg /
IFP-7503=62.7 kg /
IFP-8603=81.2 kg.

PRODUCT DESCRIPTION

- 1 Mark the eight wall mount screw hole locations on the wall.

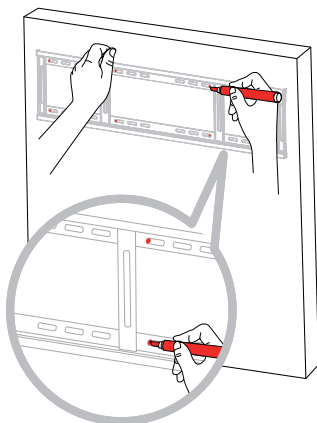

- 2 Drill eight small holes on the mounting location with the length and width 55mm x 10mm respectively.

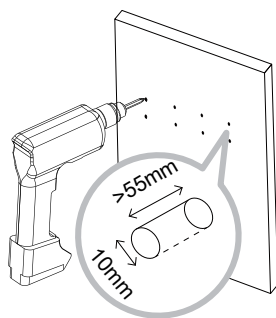

- 3 Insert a plastic anchor into each hole.

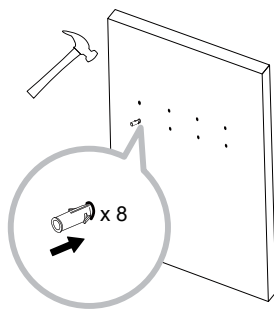

- 4 Secure the wall mount with the eight supplied screws through the washers into the eight installed anchors on the wall.

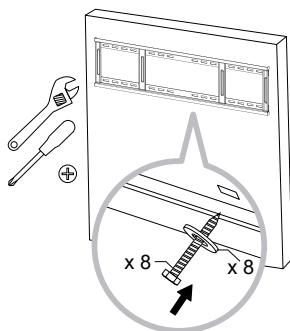

PRODUCT DESCRIPTION

- 5 Align and hook the dual wall mount on the interactive display to the wall mount.

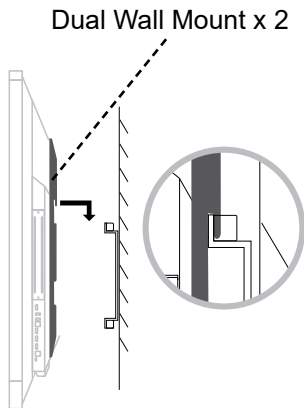

- 6 Secure the dual wall mount and the wall mount with the two screws.

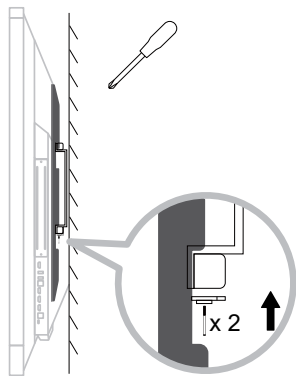

1.4.3 Ventilation Requirements for Enclosure Locating

To allow heat to disperse, leave space between surrounding objects as shown in the diagram below.

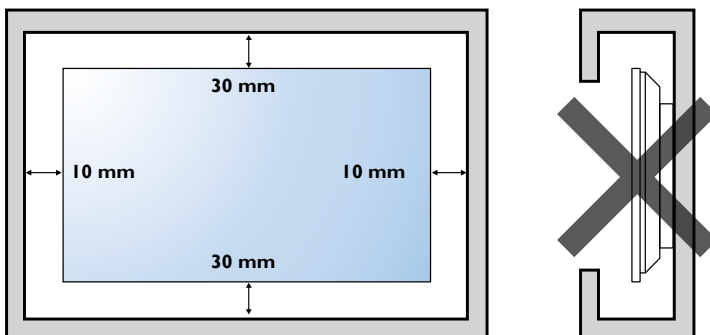

Note:

- ◆ Keep clearances around the interactive display according to the minimum dimensions as illustrated.
- ◆ Never cover the ventilation holes or insert anything into the housing.
- ◆ Do not place the interactive display in a confined space, such as a cabinet or imbedded closet. Place the display on a sturdy, level surface and make sure an appropriate ventilation is provided.



Warning:

Make sure the power cord of the interactive display is disconnected before the installation.

PRODUCT DESCRIPTION

1.5 Mounting the Interactive Display on the Stand

To mount the interactive display on the stand, you need the following items:

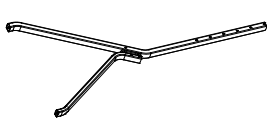

Left Leg x 1

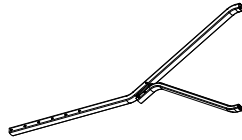

Right Leg x 1



Wall Bracket x 1



Tray x 1



Wheel x 4



Wall Hanging Strip x 2



Bolts x 14
(M8x25)



M12 Spring
Pad x 4



Screws x 2
(M6x130)

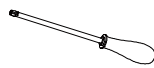

Phillips
Screwdriver
x1
(self-provided)



Adjustable
Wrench x1
(self-provided)

- 1 Attach the spring pad to the wheel. Then adjust the wheel to the brake state and rotate it into the leg. Repeat the step for the remaining wheels.

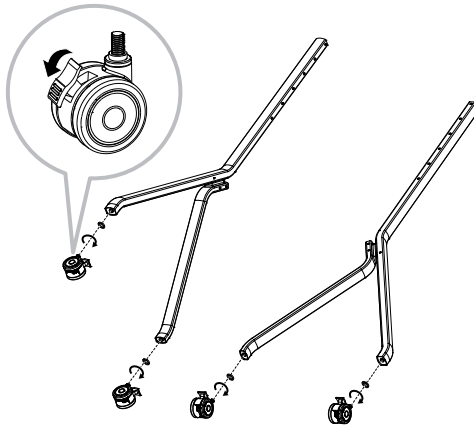

PRODUCT DESCRIPTION

- 2 Install and secure the wall bracket to the leg with the provided bolts. Make sure the wall bracket and the leg are properly aligned as indicated with black arrows in the below image.

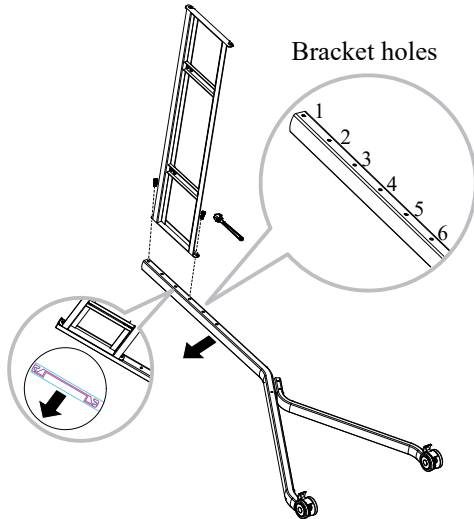

- 3 Install and secure the other leg to the wall bracket with the provided bolts.

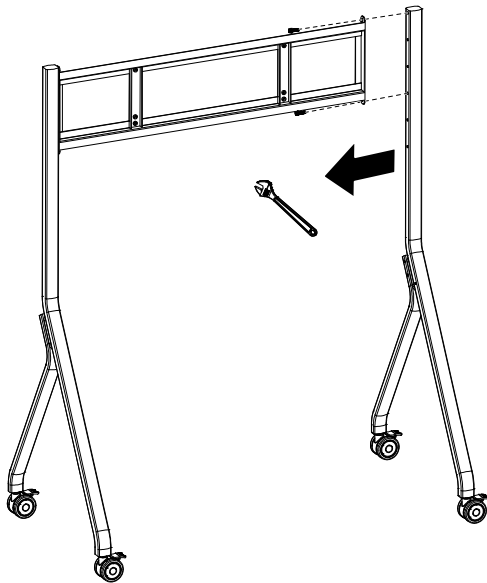

Note:

- ◆ Wall bracket hole position suggestions:

Monitor Size	Matching hole position
55"	3 rd and 6 th holes
65"- 70"	2 nd , 5 th hole
75"- 86"	1 st and 4 th hole

PRODUCT DESCRIPTION

- 4 Assemble the tray between the two columns as follows:
- a) Insert the tray into the positioning bolt on the column.
 - b) Snap the tray into the positioning bolt.
 - c) Tighten all bolts.

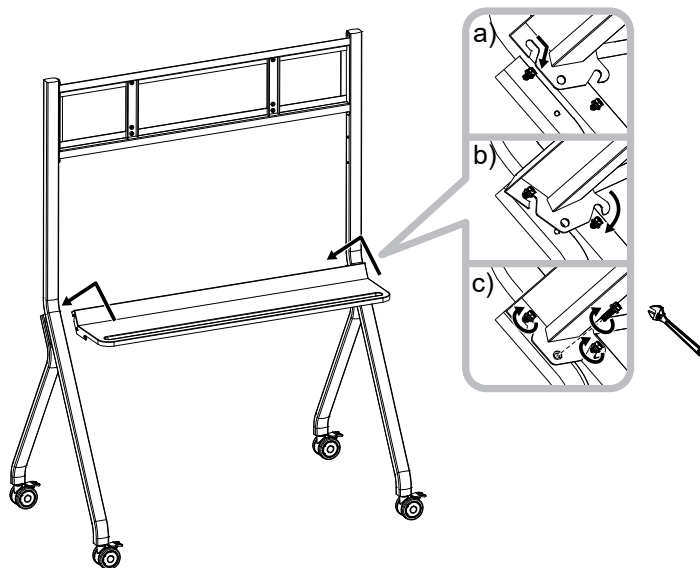

- 5 Align and secure the wall hanging strip on both sides of the interactive display. Secure the wall hanging strips to the display with the provided bolts.

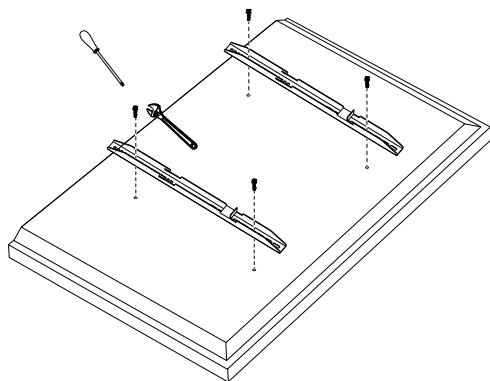

PRODUCT DESCRIPTION

- 6 Hang the interactive display assembly to the wall bracket. Then secure the safety bolts of the wall hanging strips to lock the interactive display to the stand.

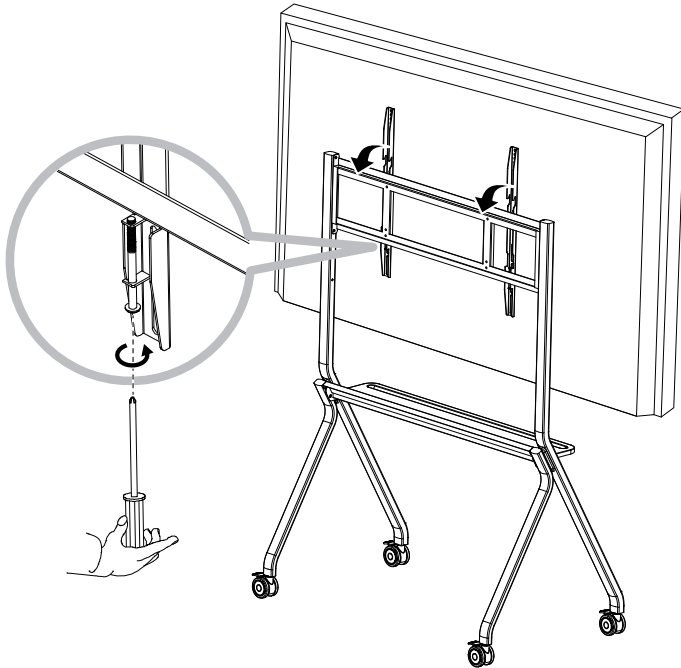

Mounting the interactive display on the stand is complete.

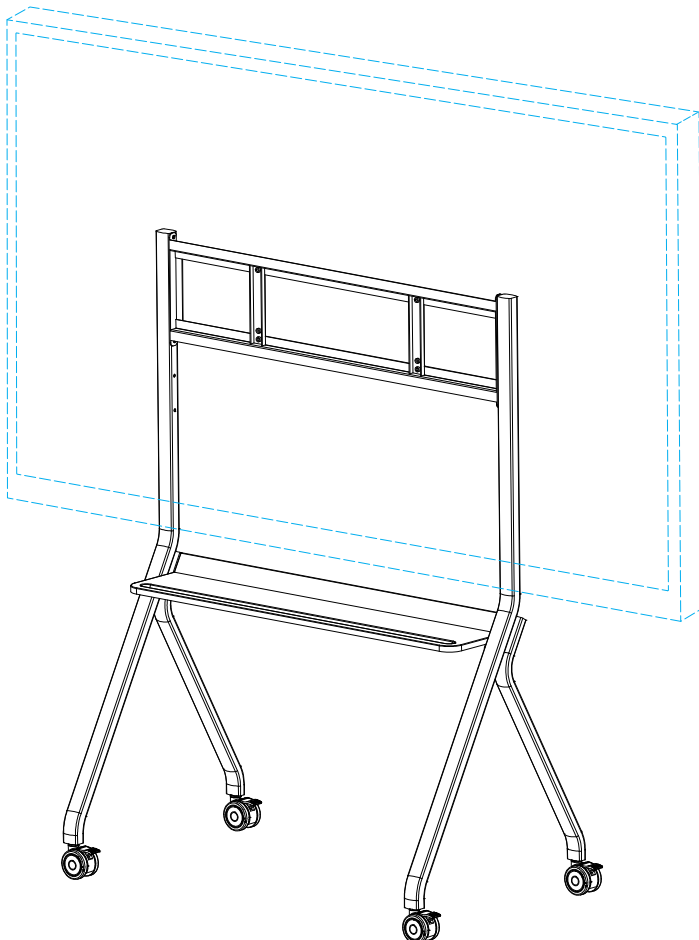

Warning:

- ◆ Make sure the wheel brakes are locked. This step requires at least 2 professionals to complete.

PRODUCT DESCRIPTION

If the interactive display's wall mounting bracket does not match with the wall mounting bracket of the stand, then do the following:

- 1 Secure the wall hanging board to the wall bracket. Make sure that the side of the wall hanging board with the locking hole is facing the front as indicated with black arrows in the below image.

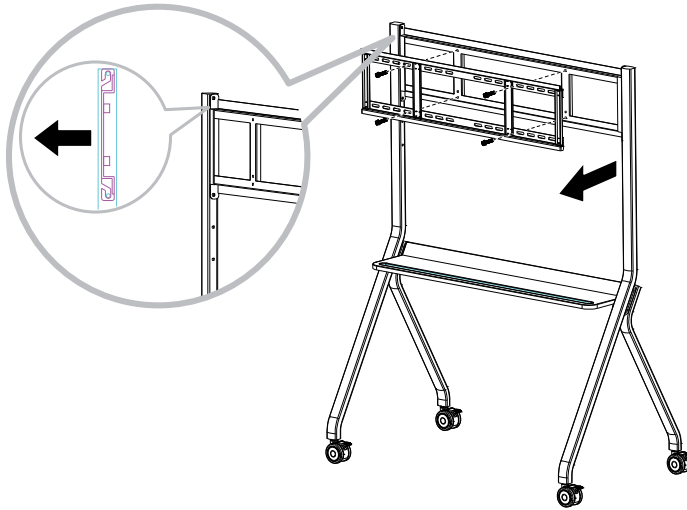

- 2 Hang the interactive display assembly to the wall bracket. Then secure the safety bolts of the wall hanging strips to lock the interactive display to the stand.

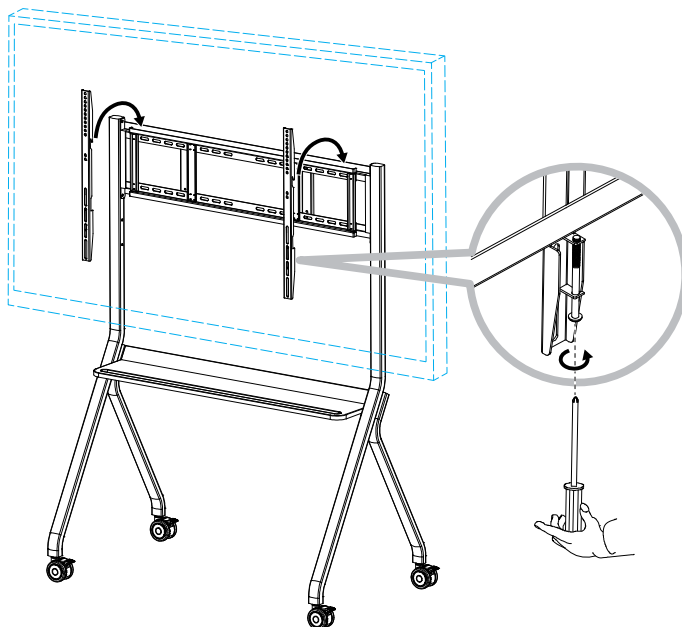

PRODUCT DESCRIPTION

1.6 Installing the Wi-Fi Module

To use wireless connectivity, you need to install the Wi-Fi module to the interactive display.

- 1 Remove the two screws from the Wi-Fi module slot cover.

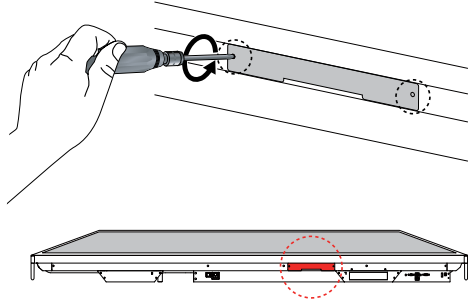

- 2 Remove the Wi-Fi module slot cover.

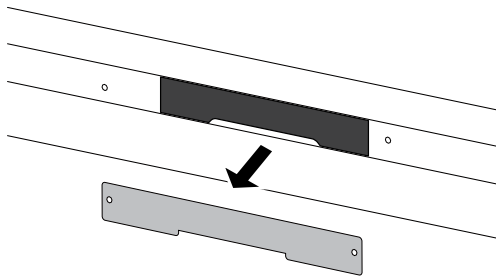

- 3 Insert the Wi-Fi module into its slot in the interactive display.

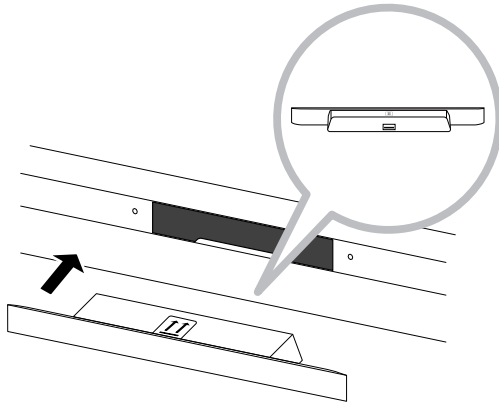

PRODUCT DESCRIPTION

1.7 Interactive Display Overview

1.7.1 Control Panel

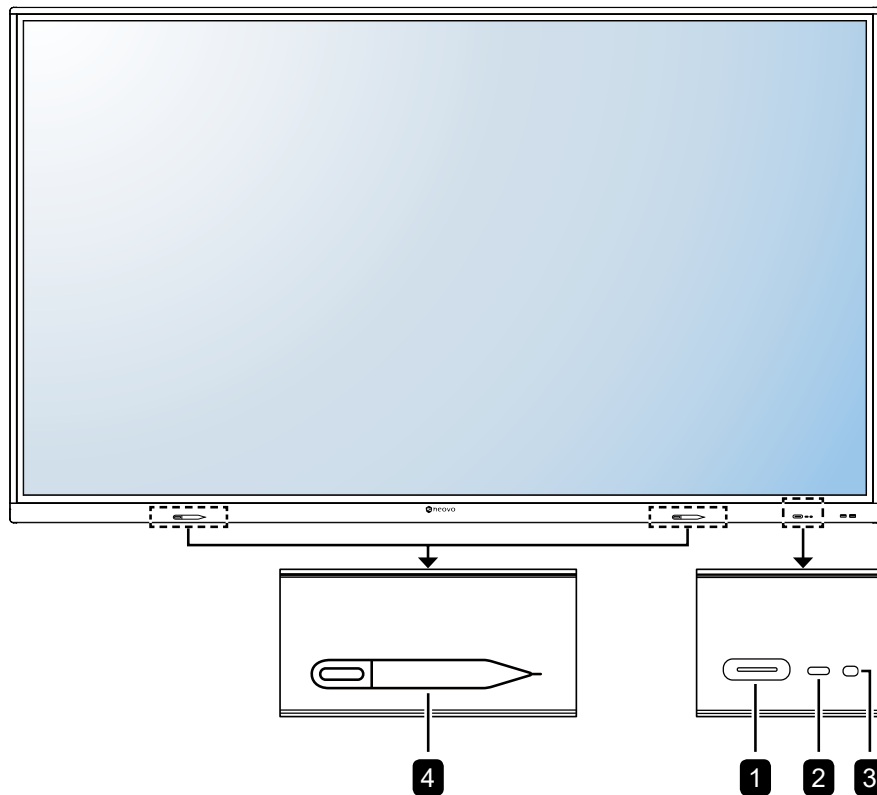

1 [⏻] POWER button with LED indicator

- Short press (<3 seconds) to turn the display on or off without shutting down the system.
- Long press (>3 seconds) to shut down the system.

LED indicator:

- White: The system is turned on.
- White/Red Flashing: The system is in standby mode.
- Red: The system is shut down.

2 Remote control sensor

Receives command signals from the remote control.

3 Auto Light sensor

With the built-in Auto Light sensor, user can enable the Auto Light feature to automatically adjust the LCD screen brightness according to the ambient light. This feature comforts the eyes and helps optimise energy efficiently.

Note: Please make sure the Auto Light sensor is not covered when enabling this function.

4 Touch pen emplacements

Magnetic areas for attaching touch pens.

PRODUCT DESCRIPTION

1.7.2 Input/Output Terminals

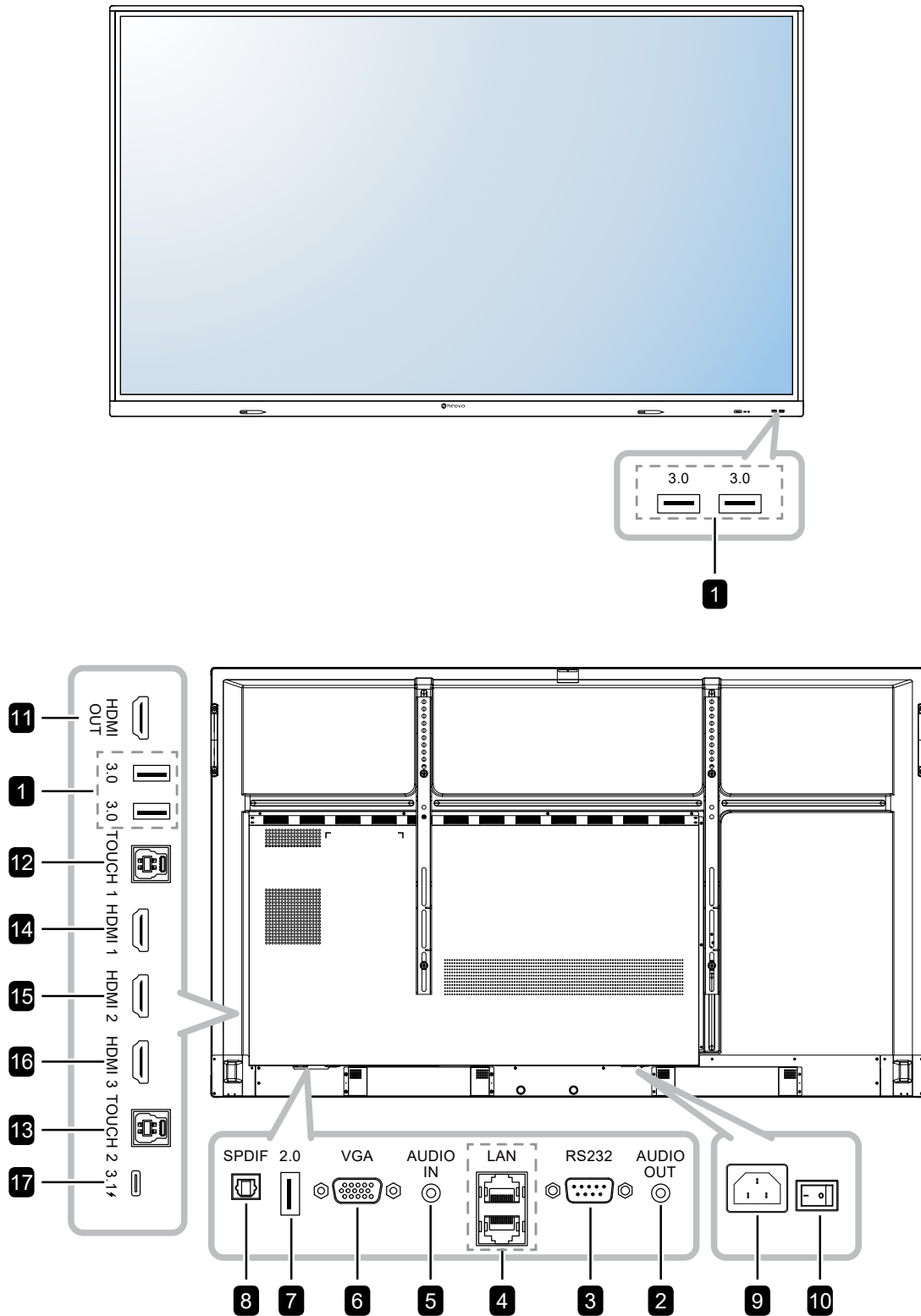

PRODUCT DESCRIPTION

- 1 3.0**
Connects to a USB interface device.
- 2 AUDIO OUT**
Connects audio signals output (3.5 mm Stereo Audio Jack).
- 3 RS232**
Connects RS232 input from external equipment.
- 4 LAN**
For internet connection with an Ethernet cable.
- 5 AUDIO IN**
Connects audio signals input (3.5 mm Stereo Audio Jack).
- 6 VGA**
Connects VGA signals input.
- 7 2.0**
Connects to a USB interface device.
- 8 SPDIF**
Connects digital audio signals output.
- 9 ~**
AC power input.
- 10 Main Power**
Switches the main power on/off.
- 11 HDMI OUT**
Connects HDMI signals output.
- 12 TOUCH 1 (USB Type-B)**
Connects USB for touch screen control.
- 13 TOUCH 2 (USB Type-B)**
Connects USB for touch screen control.
- 14 HDMI 1**
Connects HDMI signals input.
- 15 HDMI 2**
Connects HDMI signals input.
- 16 HDMI 3**
Connects HDMI signals input.
- 17 3.1 $\frac{1}{2}$ (USB Type-C)**
Connects to a USB interface device.

PRODUCT DESCRIPTION

1.8 Remote Control

1.8.1 General Functions

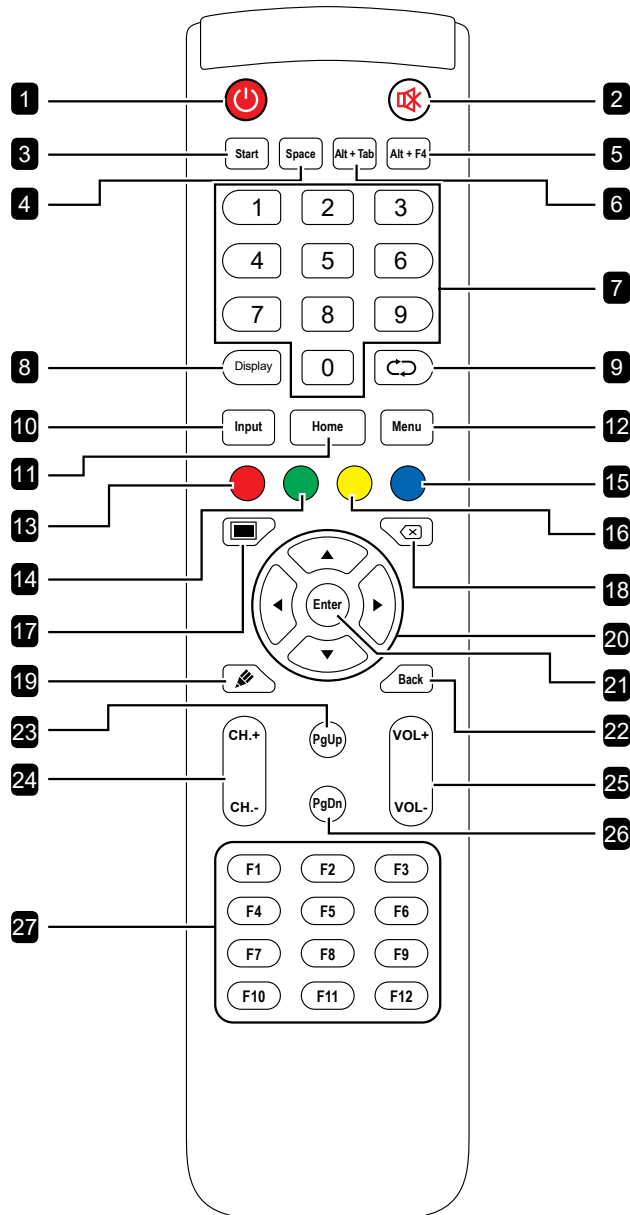

- 1 [Power] Power button:**
Turns the system on or shuts down.
- 2 [MUTE] MUTE button:**
Turns the mute function on or off.
- 3 [START] Start button:**
Opens the Start menu (Windows OS).
- 4 [SPACE] Space button:**
Functions as "Space" keyboard key.
- 5 [Alt + F4] "Alt"+"F4" button:**
Functions as "Alt"+"F4" keyboard keys (Window OS).
- 6 [Alt + Tab] "Alt"+"Tab" button:**
Functions as "Alt"+"Tab" keyboard keys (Window OS).
- 7 [Number] Number buttons:**
Enters numbers.
- 8 [Display] Display button:**
Displays channel information.
- 9 [↻] Re-sync button:**
Not supported.
- 10 [Input] Source button:**
Opens TouchMenu > General settings.
- 11 [Home] Home button:**
Returns to the Home screen (Android OS).
- 12 [Menu] Menu button:**
Opens TouchMenu > OSD Menu.
- 13 [Red] Red button:**
Enables or disables the Front keyboard and Touch function.
- 14 [Green] Green button:**
Enables or disables the front keyboard.
- 15 [Blue] Blue button:**
Opens or closes the screen freezing tools.
- 16 [Yellow] Yellow button:**
Enables or disables the Touch function.
- 17 [Screen] Screen backlight button:**
Turns on or off the screen backlight.
- 18 [X] Backspace button:**
Functions as "Backspace" keyboard key.
- 19 [Pencil] Writing mode button:**
Press the button to open the **Meetboard** app and start writing on the screen.
- 20 [Navigation] Navigation buttons:**
Navigates through the OSD menu and adjusts the settings.

PRODUCT DESCRIPTION

21 [Enter] Enter button:

Confirms your selection or saves the modifications.

22 [Back] Back button:

Returns to the previous screen (Android OS) or exits the OSD menu.

23 [PgUp] Page Up button:

Functions as "PageUp" keyboard key.

24 [CH.+] [CH.-] Channel button:

No function.

25 [VOL+] [VOL-] Volume button:

Adjusts volume on internal or external audio sources.

26 [PgDn] Page Down button:

Functions as "PageDown" keyboard key.

27 [F1-F12] F1-F12 buttons:

Function as "F1" to "F12" keyboard keys.

Note:

- ◆ While the interactive display is powered on and you press the keyboard button, the **POWER** button LED indicator blinks red once and then turns back white.
- ◆ You need to press the Red button and the Yellow button at the same time to completely unlock the screen.

PRODUCT DESCRIPTION

1.8.2 Inserting the Batteries in the Remote Control

The remote control is powered by two 1.5V AAA batteries.

To install or replace batteries:

- 1 Unlatch and then remove the battery compartment cover.
- 2 Align the batteries according to the (+) and (-) indications inside the battery compartment.
- 3 Replace the battery compartment cover.

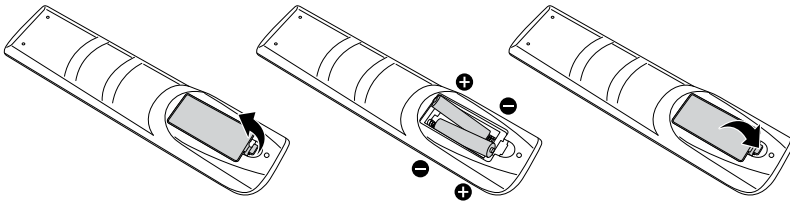

1.8.3 Handling the Remote Control

- Do not subject to strong shock.
- Do not allow water or other liquid to splash the remote control. If the remote control gets wet, wipe it dry immediately.
- Avoid exposure to heat and steam.
- Other than to install the batteries, do not open the remote control.

Caution:

The incorrect use of batteries can result in leaks or bursting. Be sure to follow these instructions:

- ◆ Place “AAA” batteries matching the (+) and (-) signs on each battery to the (+) and (-) signs of the battery compartment.
- ◆ Do not mix battery types.
- ◆ Do not combine new batteries with used ones. It causes shorter life or leakage of batteries.
- ◆ Remove the dead batteries immediately to prevent them from liquid leaking in the battery compartment. Don't touch exposed battery acid, as it can damage your skin.

Note:

- ◆ If you do not intend to use the remote control for a long period, remove the batteries.
- ◆ The remote control may not function properly when the remote control sensor on this display is under direct sunlight or strong illumination, or when there is an obstacle in the path of signal transmission.

PRODUCT DESCRIPTION

1.8.4 Operating Range of the Remote Control

Point the top of the remote control toward the display's remote control sensor (on the left or right side) when pressing a button.

When using the remote control, the distance from the remote control to the sensor on the display should be less than 8m/26ft, and the horizontal and vertical angles should be less than 30°.

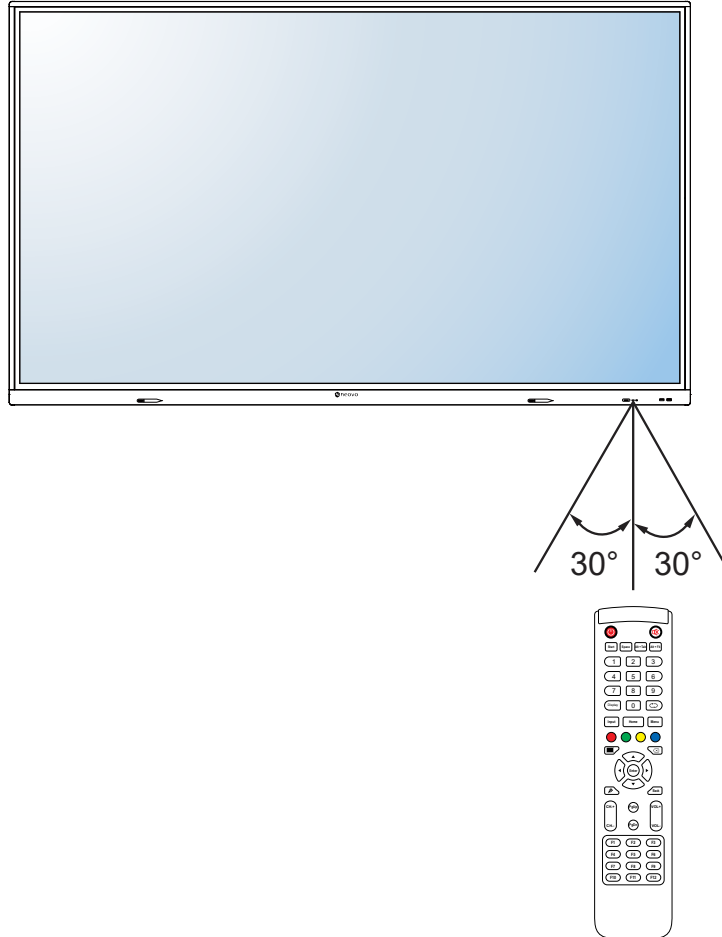

CHAPTER 2: MAKING CONNECTIONS

2.1 Connecting the Power

Note:

- ◆ To operate the interactive display, ensure to use the correct power cord that matches the power outlet in your region.
- 1 Connect one end of the power cord to the AC IN connector on the interactive display.
 - 2 Connect the other end of the power cord to a power outlet or a power supply.
 - 3 Set the **Main Power** switch to ON.

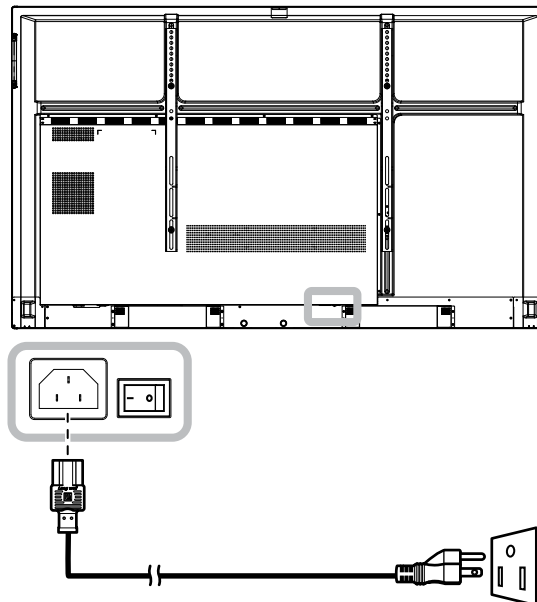

⚡ Caution:

- ◆ Make sure that the interactive display is not connected to the power outlet before making any connections. Connecting cables while the power is ON may cause electric shock or personal injury.
- ◆ When unplugging the power cord, hold the power cord by the plug head. Never pull by the cord.

MAKING CONNECTIONS

2.2 Connecting a Computer or Portable Device

2.2.1 Using VGA (D-Sub) Input

Connect one end of a VGA cable to the VGA connector of the interactive display and the other end of a VGA cable to the VGA OUT connector of the computer.

For audio input, connect one end of an audio cable to the AUDIO IN connector of the interactive display and the other end of an audio cable to the AUDIO OUT connector of the computer.

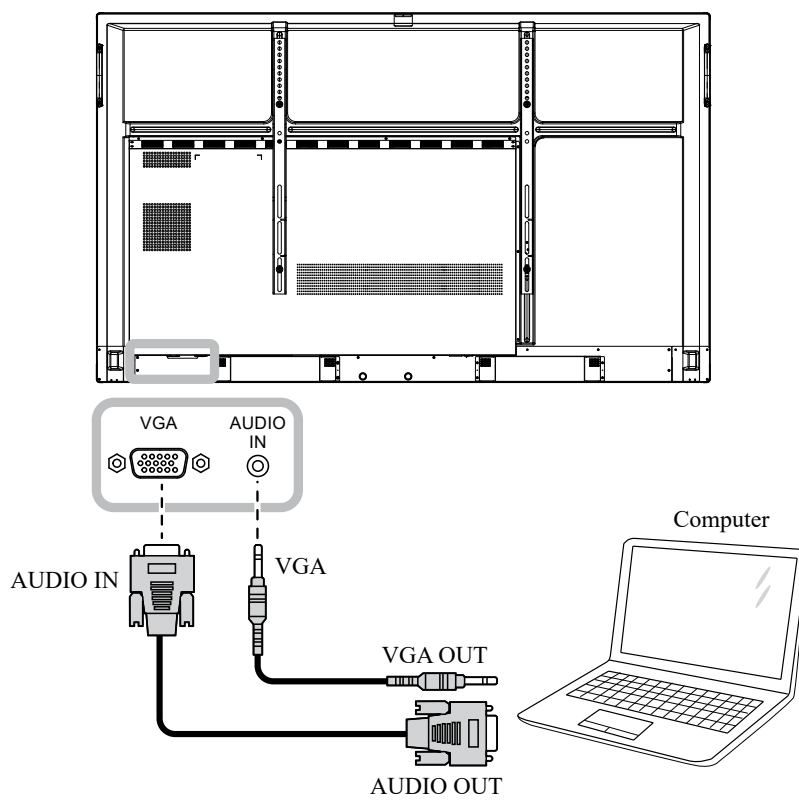

MAKING CONNECTIONS

2.2.2 Using RS232 Input

Connect one end of a RS232 serial cable to the RS232 connector of the interactive display and the other end of an RS232 serial cable to the RS232 connector of the computer.

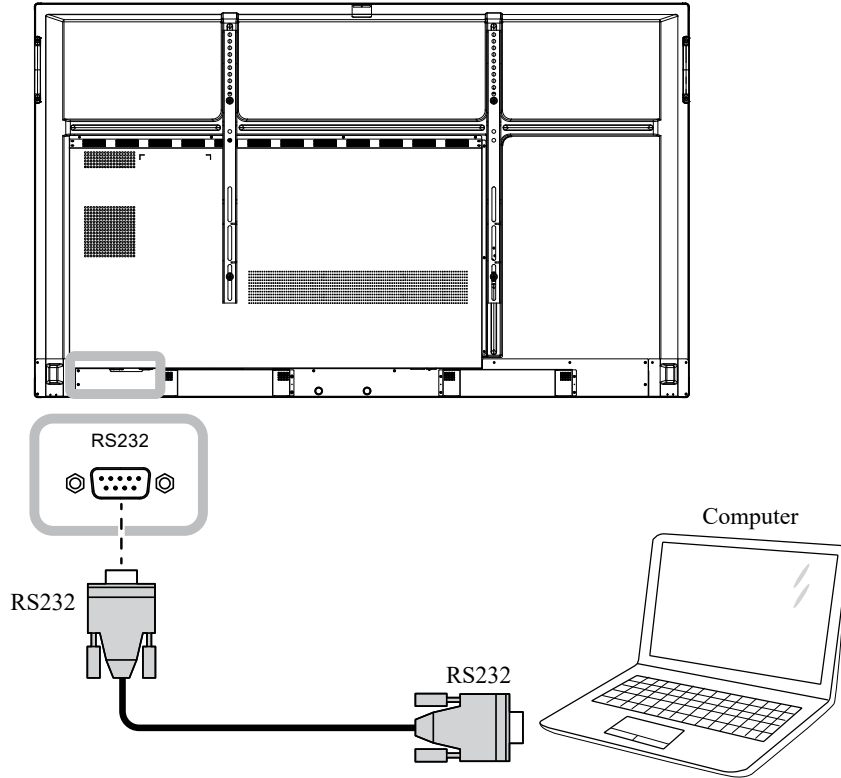

2.2.3 Using HDMI Input

Connect one end of an HDMI cable to the HDMI 1, HDMI 2, or HDMI 3 connector of the interactive display and the other end of an HDMI cable to the HDMI OUT connector of the computer.

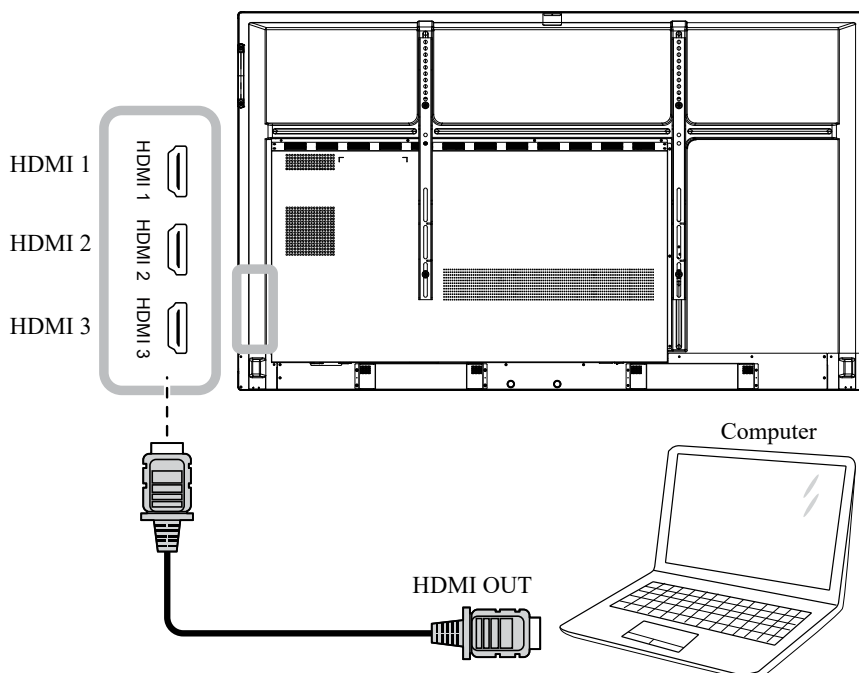

MAKING CONNECTIONS

2.2.4 Using the Touch Module

Interactive display has touch screen functionality which allows you to connect a computer to the display and control the computer's interface via touch gestures on the display. To use this touch screen function, connect the USB cable to the TOUCH 1 or TOUCH 2 port of the display and a computer or USB cable to the 3.1 ϕ port of the display and a computer.

In addition, perform the following connection:

- For TOUCH 1, connect one end of the HDMI cable to the HDMI 1 or HDMI 2 port of the display and the other end of the HDMI cable to the HDMI OUT port of the computer.
- For TOUCH 2, connect one end of the HDMI cable or VGA cable to the HDMI 3 port or VGA port of the display and the other end of the HDMI cable or the VGA cable to the HDMI OUT port or VGA OUT port of the computer respectively.
- For USB type-C, connect one end of the USB cable to the 3.1 ϕ port of the display and the other end of the USB cable to the USB type-C port of the computer.

For compatibility options, refer to the following table:

	HDMI 1	HDMI 2	HDMI 3	VGA
TOUCH 1	○	○	X	X
TOUCH 2	X	X	○	○

TOUCH 1

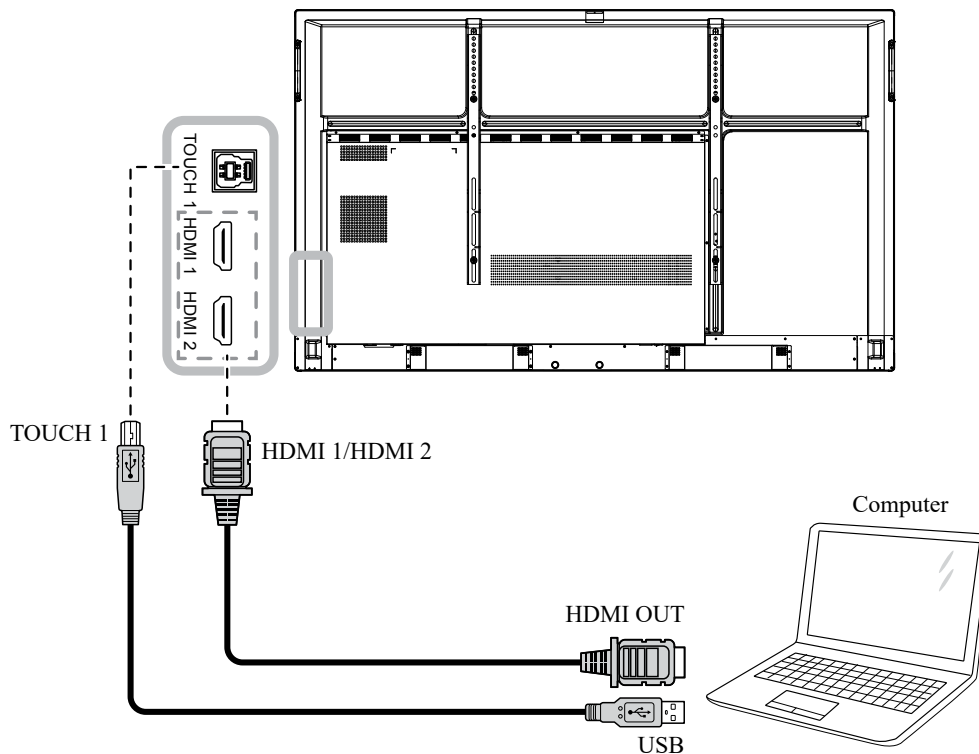

MAKING CONNECTIONS

TOUCH 2

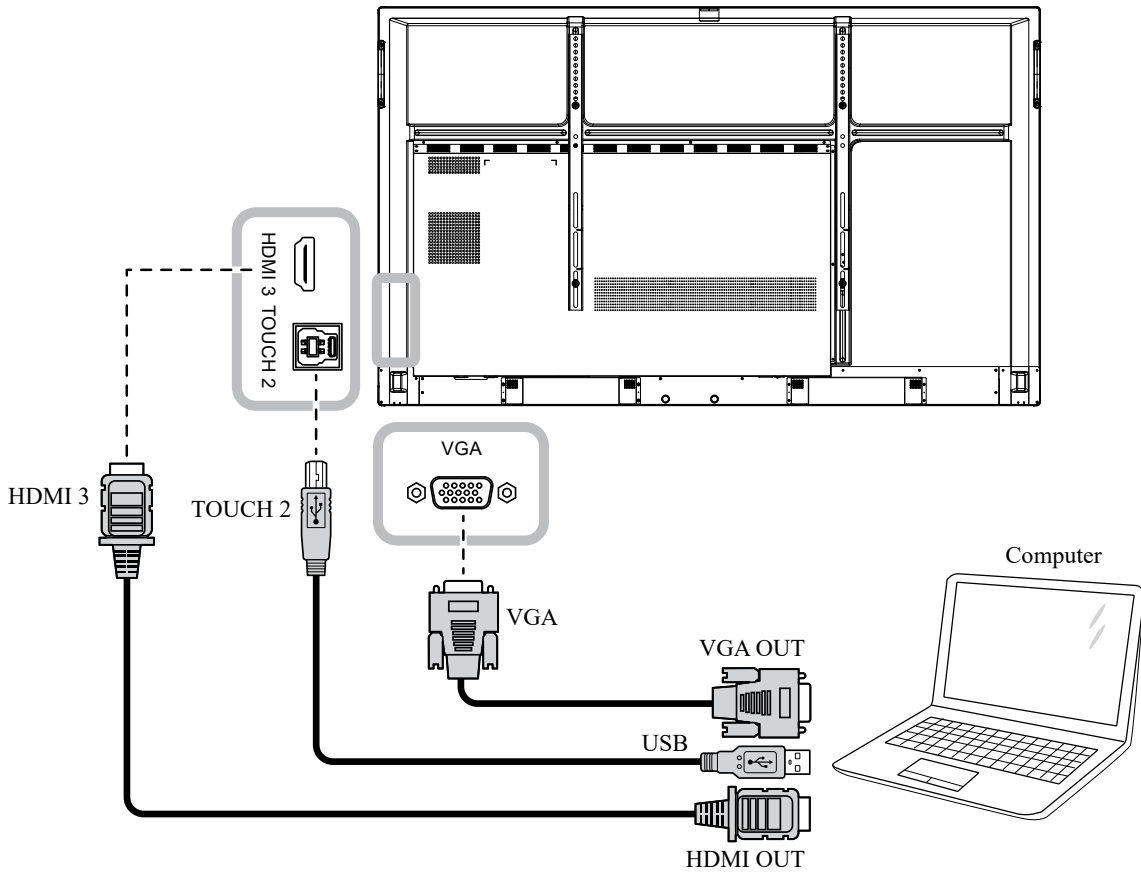

USB Type-C

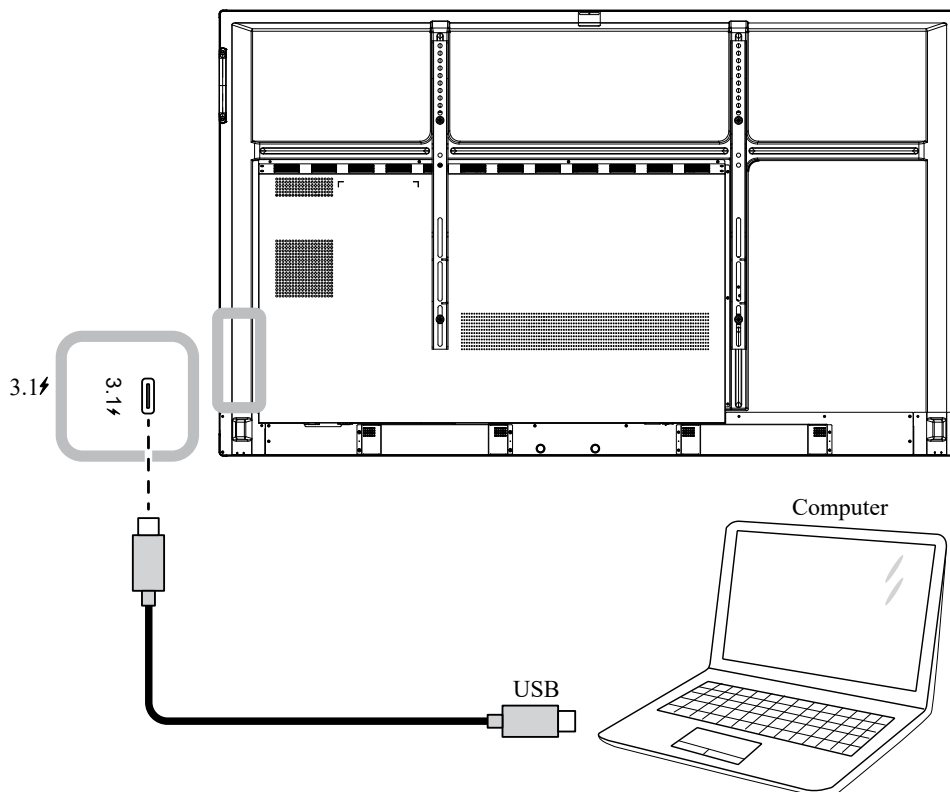

MAKING CONNECTIONS

Note:

- ◆ The touch driver will be installed automatically for the following operating systems:
 - One-touch point for Windows 2000/XP/Vista/CE 6.0 and macOS.
 - Multi-touch point Windows 7/8/10/11, Android/Linux (kernel version 3.5+) and Chrome OS (39 or above).
- ◆ Certain touch gestures, such as zoom-in, zoom-out and rotate, may not work depending on the application or software your computer supports.
- ◆ This Touch USB port works only for the touch screen functionality and does not support the external USB devices, such as MP3, printer, and hard drive, or other devices.

2.3 Connecting External Equipment (Video Player)

Connect one end of an HDMI cable to the HDMI 1, HDMI 2, or HDMI 3 connector of the interactive display and the other end of an HDMI cable to the HDMI OUT connector of the video player.

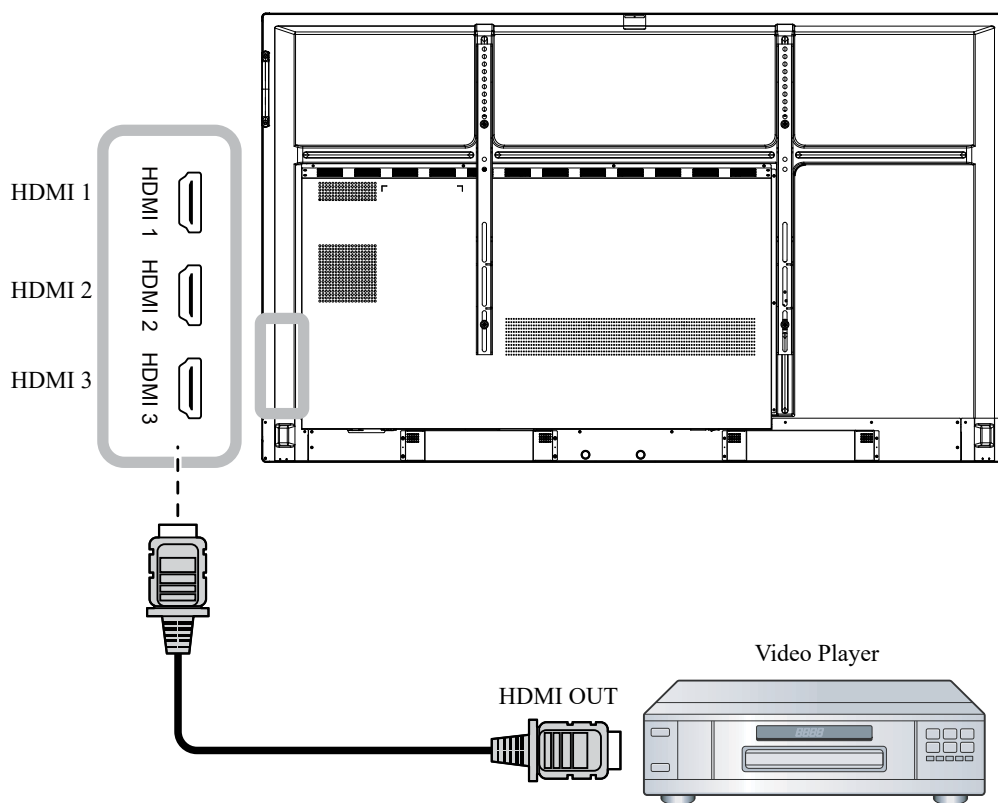

MAKING CONNECTIONS

2.4 Connecting a Display Device

Connect one end of an HDMI cable to the HDMI OUT connector of the interactive display and the other end of an HDMI cable to the HDMI IN connector of the display device.

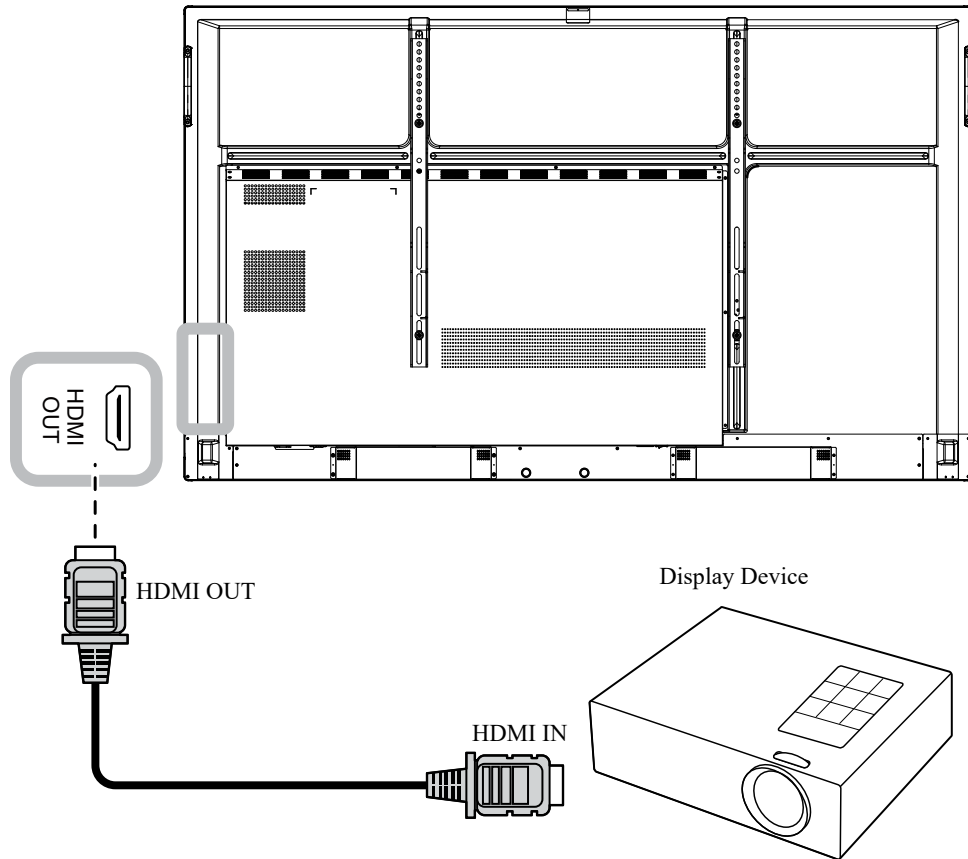

MAKING CONNECTIONS

2.5 Connecting to a Wired Network

Connect one end of a network cable (RJ45) to the LAN connector of the interactive display and the other end of a network cable to a network hub, switch, or router.

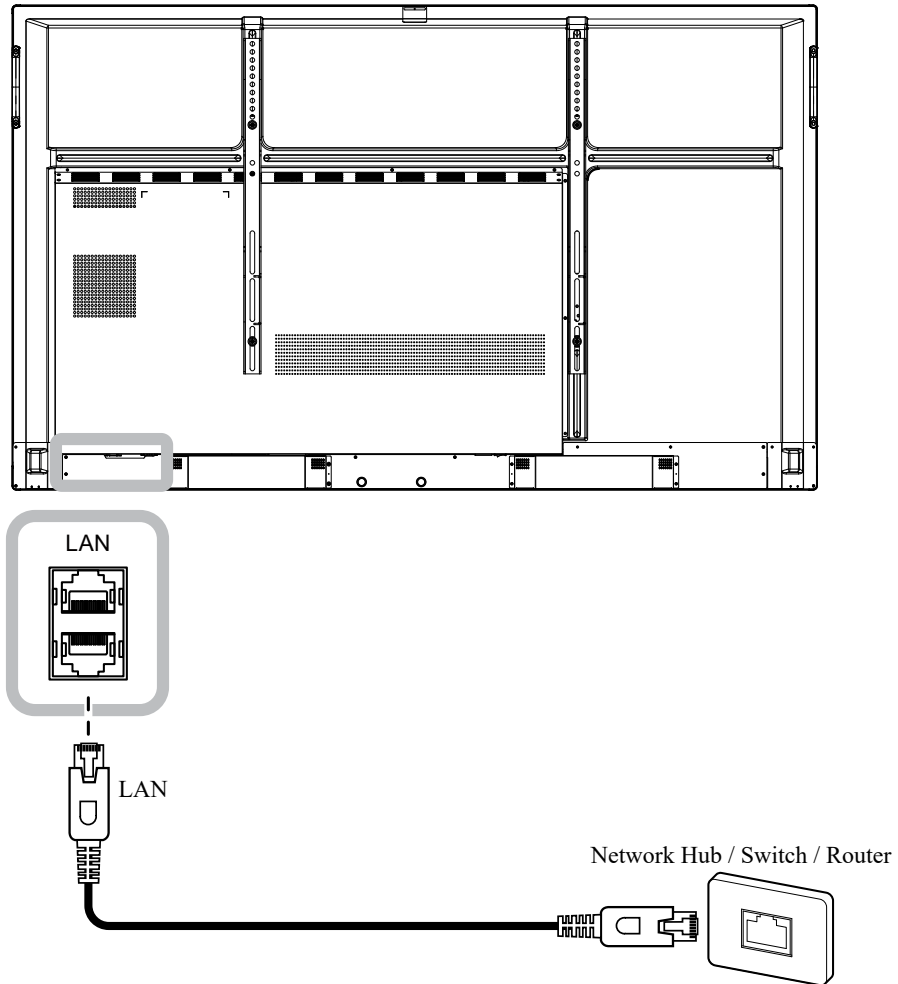

MAKING CONNECTIONS

2.6 Connecting Audio Equipment

Connect one end of an audio cable to the AUDIO OUT connector of the interactive display and the other end of an audio cable to the AUDIO IN connector of the audio device.

For digital audio output, connect one end of an audio cable to the SPDIF connector of the interactive display and the other end of an audio cable to the SPDIF IN connector of the audio device.

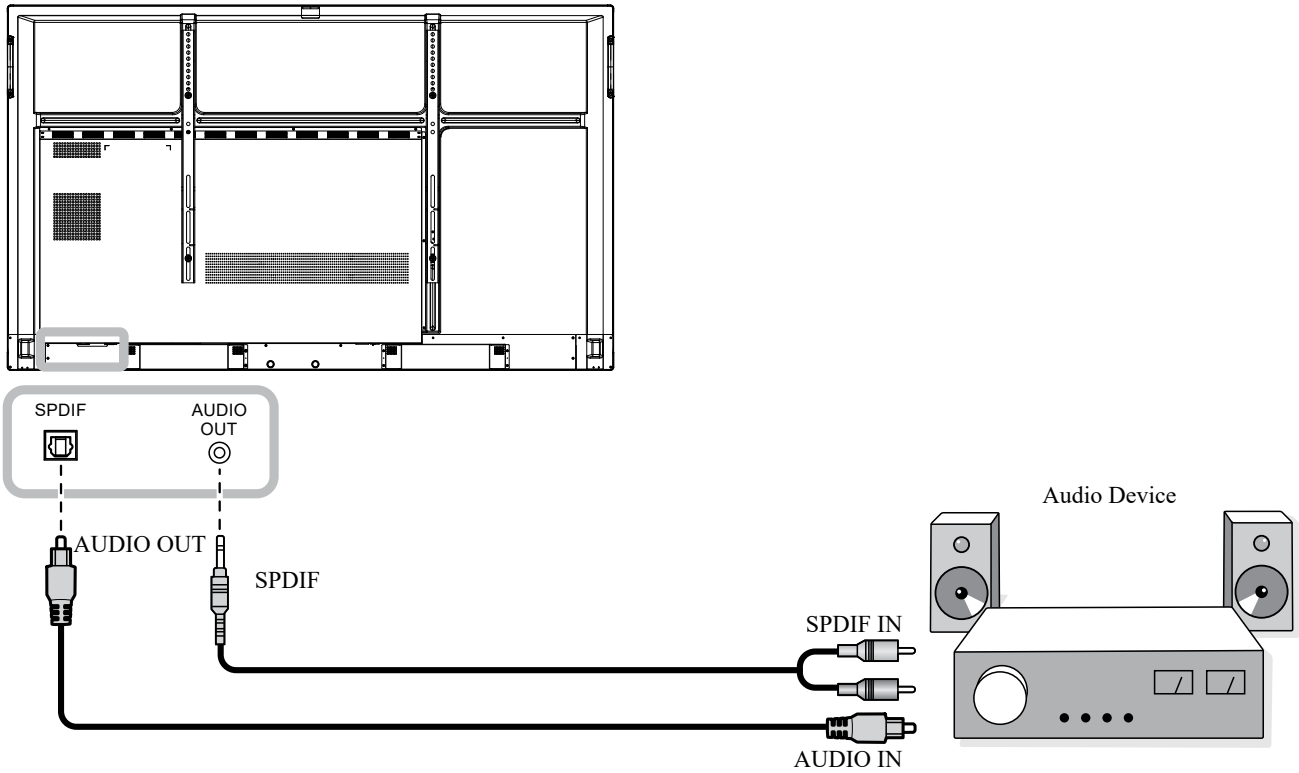

MAKING CONNECTIONS

2.7 Connecting USB Interface Devices

Connect a USB interface device to 2.0 or 3.0 ports of the interactive display.

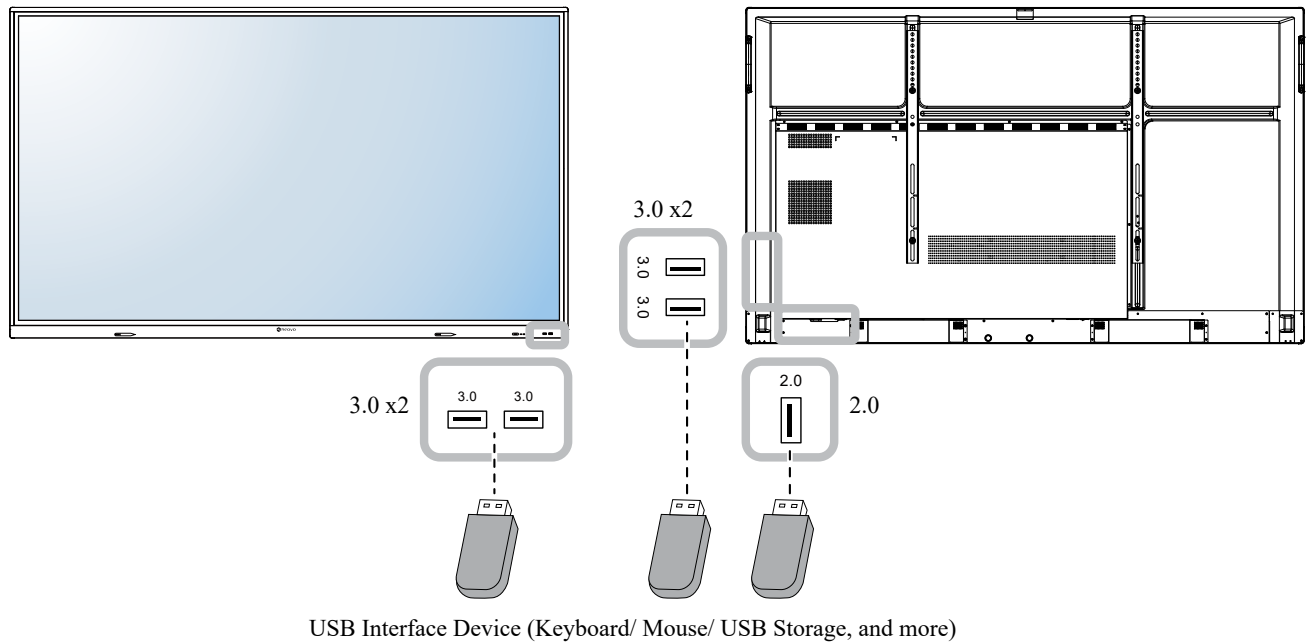

2.8 Attaching Touch Pens

Attach the touch pen to the magnetic areas on the interactive display's front panel.

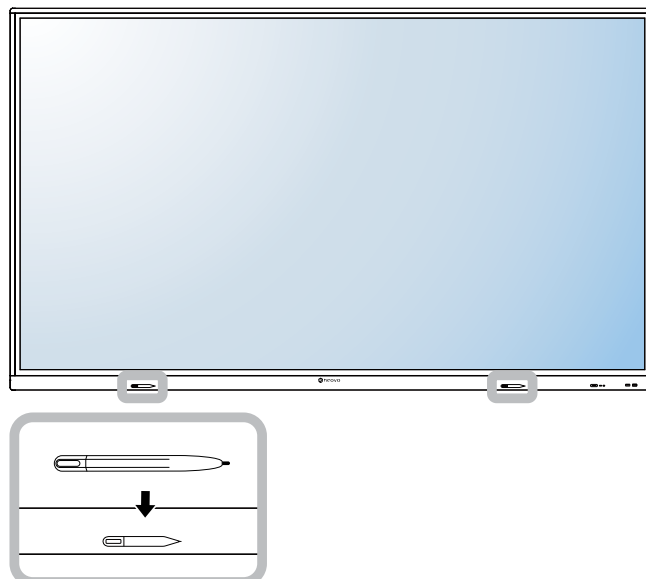

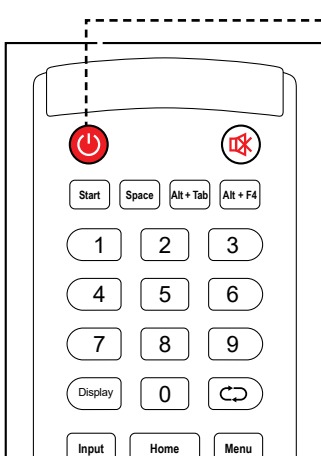

CHAPTER 3: USING THE INTERACTIVE DISPLAY

3.1 Turning on the Power



POWER button

- 1 Plug the power cord to a power outlet or power supply.
- 2 Set the **Main Power** switch to ON.
- 3 Press the  button to turn the interactive display on.

When the interactive display is turned on, press the  button to turn off the interactive display.



Note:

- ◆ The interactive display still consumes power as long as the power cord is connected to the power outlet. Disconnect the power cord to completely cut off power.

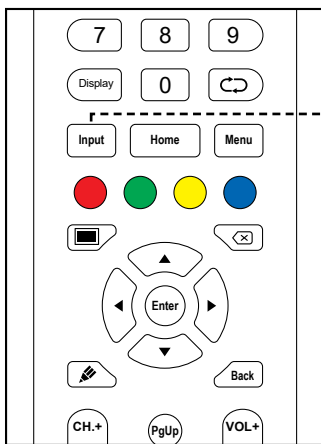
3.2 Selecting the Input Source Signal



Input button

- 1 Press the **Input** button.
- 2 Press the  or  button to select a source.
- 3 Press the **Enter** button to confirm the selection / switch to the selected input source.

Note:

- ◆ After pressing the **Input** button or swiping up from the bottom edge of the screen, the General settings menu will be displayed on the screen.



Note:

- ◆ If the selected input source signal is not connected to the interactive display or is turned off, the screen will display “**No signal**” message.



- ◆ All available sources are indicated by  below them.
- ◆ The selected source has a green circle around the source icon.

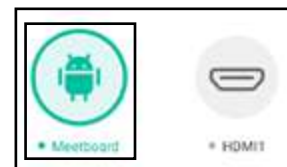

USING THE INTERACTIVE DISPLAY

3.3 Adjusting the Volume

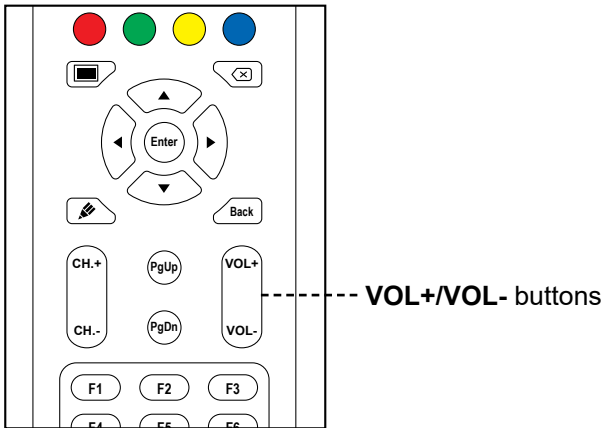

Press the **VOL-** or **VOL+** button to adjust the volume level.

3.4 Using Freeze Function

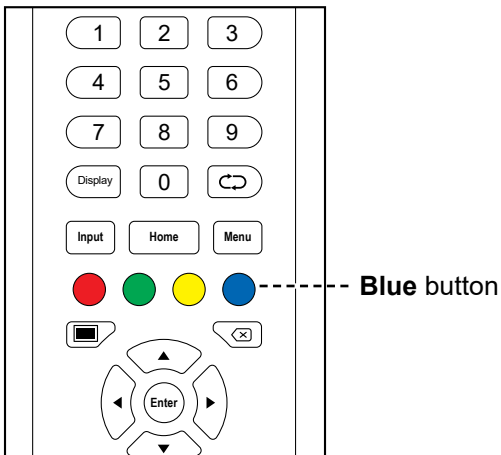

Press the **Blue** button to freeze the screen image but still continue real-time playback until the image is unfreeze. The freeze control bar () and the icon will appear on the screen.

While the screen freeze is activated, you can perform the following operations:

- : Zoom in on the image.
- : Zoom out on the image.
- : Display the screen image in its original ratio.
- : Close the freeze control bar and unfreeze.

The screen image displays the elapsed real-time playback image when screen freeze is deactivated.

Note:

- ◆ After pressing the **VOL-** or **VOL+** button, the volume menu is displayed on the screen automatically.
- 
- ◆ Press the button to mute the audio. When muted, the icon appears on the screen.

Note:

- ◆ You can unfreeze the screen also by pressing the **Back** or **Blue** button.

USING THE INTERACTIVE DISPLAY

3.5 Android Functions

3.5.1 Accessing the Home Screen

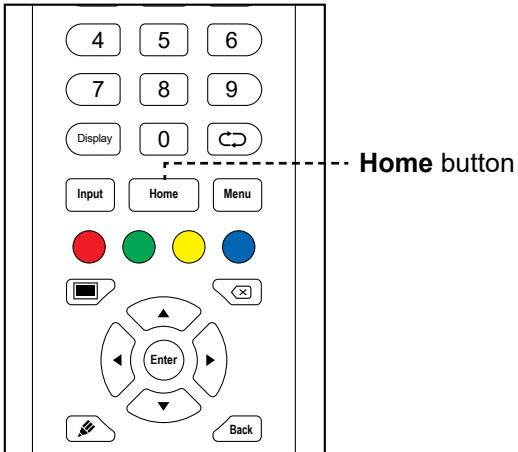

Press the **Home** button to access the Home screen of the system.

3.5.2 Returning to the Previous Screen

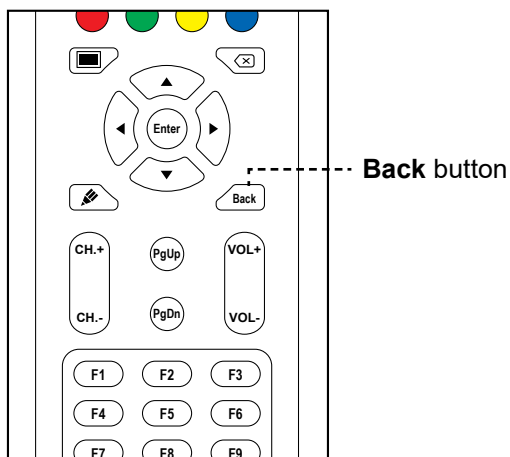



Press the **Back** button to return to the previous screen.

USING THE INTERACTIVE DISPLAY

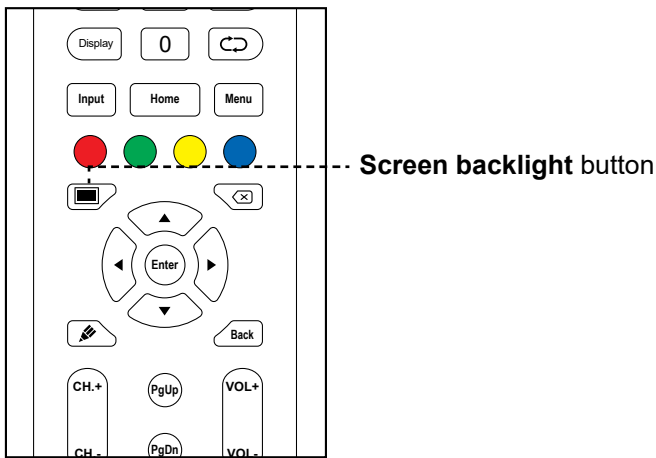
3.5.3 Blanking the Screen



Press the  button to blank the screen. The screen turns black. Press the  button again to turn on the screen backlight.

3.5.4 Activating the Writing Mode

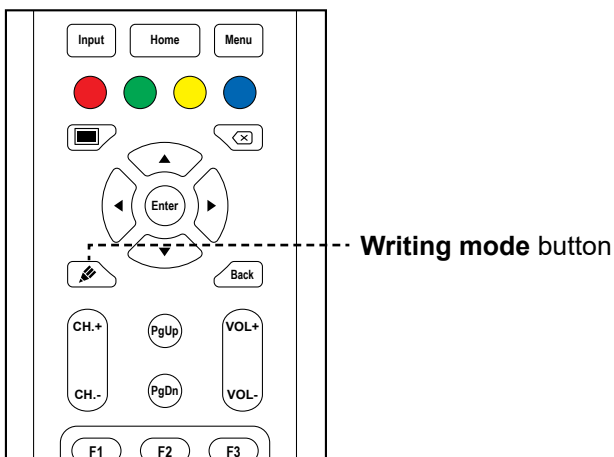





Press the  button to open the **Meetboard** app and start writing on the screen.

USING THE INTERACTIVE DISPLAY



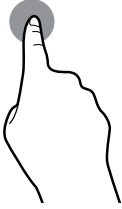
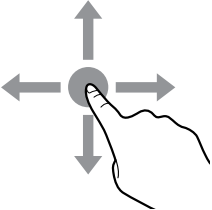

3.6 Using the Touchscreen

In addition to the remote control, you can also operate your interactive display using the touch gestures as described in the tables below.

For Android

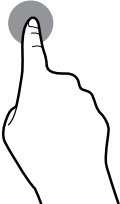
Action	Touch Gesture	Function
Touch		<p>Touch to open clickable items on the screen, such as apps, Assistive menu options, and more.</p> <p>Note:</p> <ul style="list-style-type: none"> ◆ Always touch the screen with your finger or with the supplied touch pen. ◆ Do not touch the screen with sharp, metallic objects that could scratch the screen's coating.
Touch and hold		<ul style="list-style-type: none"> • Review and control the app <ol style="list-style-type: none"> a) On the Apps screen, touch and hold the app icon that you want to review. b) Drag the app onto the App info at the top of the screen and then release. The app's information screen opens.
Drag or swipe		<div style="text-align: right;">  ↓ </div> <div style="text-align: right;">  </div> <ul style="list-style-type: none"> • Touch and hold on either of the Assistive menu icons  / , then drag it up or down based on your preference. • In the General settings menu, drag the slider bar to the left or to the right to adjust the item value.

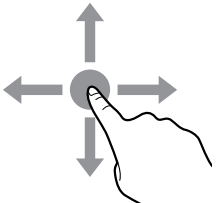
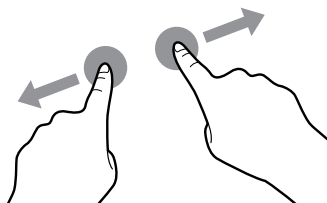
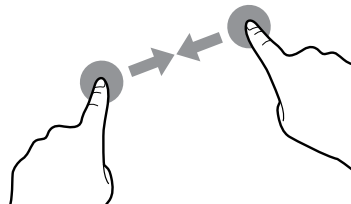
USING THE INTERACTIVE DISPLAY

Action	Touch Gesture	Function
Touch and hold <i>(continued)</i>		<ul style="list-style-type: none"> Touch and hold on the Home screen to add a widget or change the Home screen wallpaper. 
Drag or swipe <i>(continued)</i>		
Zoom	<p>Zoom in</p>  <p>Zoom out</p> 	<ul style="list-style-type: none"> Zoom in and zoom out on the image. <p>For example:</p> <p>Zoom in</p>  <p>Zoom out</p> 



For Windows

Note:

- ◆ Make sure you have connected properly the Windows-based device to the interactive display.
- ◆ Multi-touch functions are only supported on Windows 11, Windows 10, Windows 8, Windows 7 Home Premium /Professional / Enterprise / Ultimate operating systems and not supported on Windows XP, Windows Vista, and Windows 7 Starter / Home Basic.
- ◆ Windows is a registered trademark of Microsoft Corporation in the United States and other countries.

Function	Touch Gesture	Action
Single-touch gestures:		
Note:		
◆ For Windows XP, Windows Vista, Windows 7, Windows 8, Windows 10, and Windows 11.		

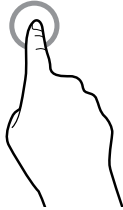
USING THE INTERACTIVE DISPLAY

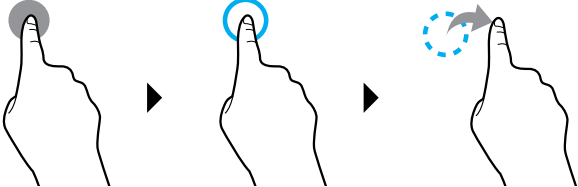
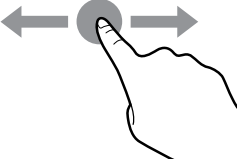
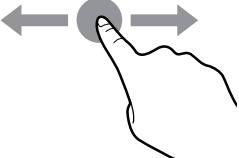
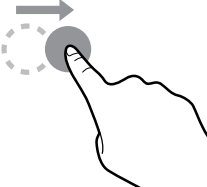
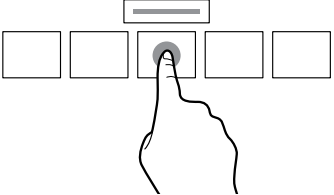
Function	Touch Gesture	Action
Tap		Touch the screen once.
Double-tap		Touch the screen twice.
Right-tap		Touch and hold on the target until a blue ring appears. Then release your finger.
Drag		Touch the screen and drag with one finger to the left or to the right.
Note:		
◆ For Windows Vista, Windows 7, Windows 8, Windows 10, and Windows 11.		
Selection		Touch the screen and drag with one finger to the left or to the right.
Pan up / Pan down / Back / Forward		Touch the screen and quickly drag your finger to the desired direction.
Note:		
◆ For Windows 8		
Learn		Touch and hold the screen to display more information. Anything displayed this way should not prevent you panning.

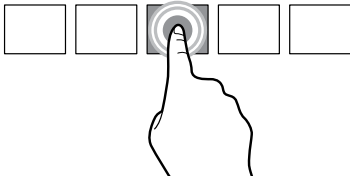
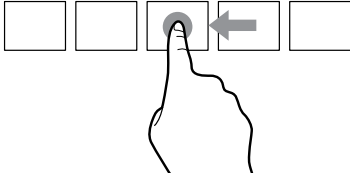
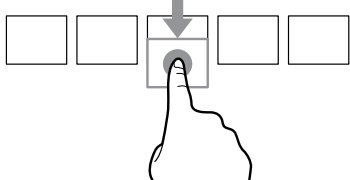
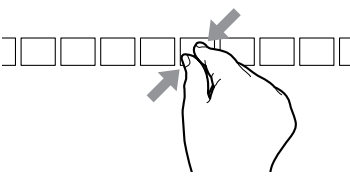
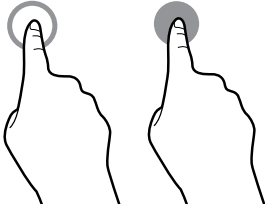
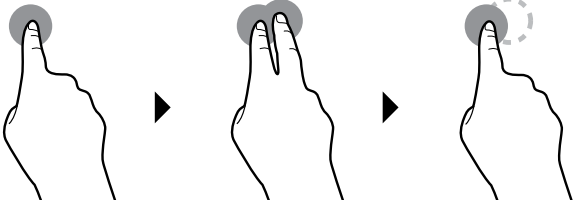

USING THE INTERACTIVE DISPLAY

Function	Touch Gesture	Action
Primary action		Touch the target to invoke its primary action. For example, launch an app or execute a command.
Pan		Touch the screen and slide for panning interactions, moving items, drawing, or for writing. Slide can also be used to target small, densely packed elements by scrubbing (sliding the finger over related objects, such as radio buttons).
Select, command, and move		Touch the screen and swipe to select, command, and move. Sliding your finger a short distance, perpendicular to the panning direction, selects objects in a list or grid and displays the app bar with related commands when objects are selected.
Zoom		Touch the screen and pinch or stretch to zoom out or zoom in respectively. The pinch and stretch gestures are more commonly used for resizing but also enable to move to the beginning, end, or anywhere within content with semantic zoom.
Note:		
◆ For Windows XP, Windows Vista, and Windows 7		
Wake the computer up from the standby mode (S3)		Touch and hold the screen for around 4 seconds.
Multi-touch gestures:		
Note:		
◆ For Windows 7 Home Premium / Professional / Enterprise / Ultimate version		
Right-tap		Touch and hold on the target and quickly touch the screen once with another finger.

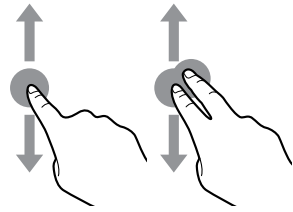
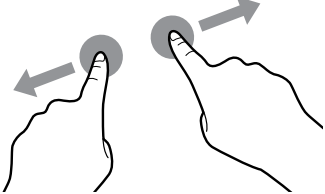
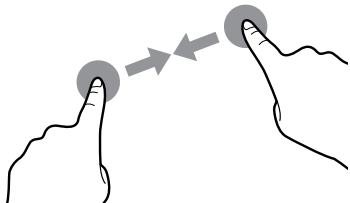
USING THE INTERACTIVE DISPLAY

Function	Touch Gesture	Action
Scrolling		Touch and drag the screen with one or two fingers up or down.
Zoom	<p>Zoom in</p>  <p>Zoom out</p> 	Touch the target and move your two fingers apart or toward each other to zoom in or zoom out respectively.

3.7 Using the On-Screen Keyboard

Whenever you need to input text, an on-screen keyboard opens automatically. Touch the keys on the screen as you would press the keys on a connected keyboard. You can also relocate the on-screen keyboard by holding and dragging the keyboard by the  icon to the desired location on the screen. To close the on-screen keyboard, press .



CHAPTER 4: USING THE SYSTEM

4.1 About the Home Screen

After you power on the system, you will see the Home screen. On the Home screen, you can view the current date and time, access the Assistive menu and various apps, check system status, and remote code.

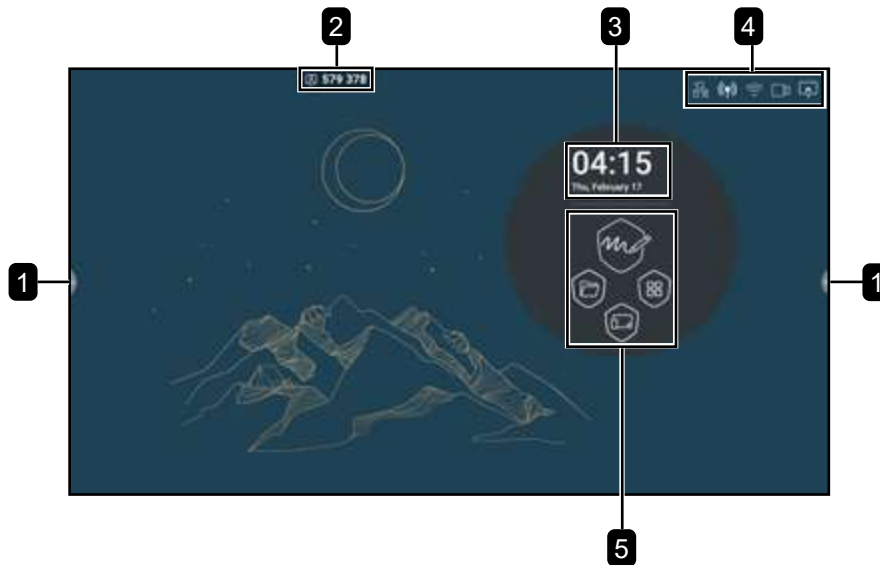

#	Item	Description
1	Assistive menu	Quick access for moving backwards, accessing the Home screen, managing recently used apps, opening various apps, enabling annotation function, and rearranging tools icons in the Assistive menu. Refer to pages 48-49. Note: ◆ The Assistive menu icons  are visible on both sides of the interactive display.
2	Remote Code	Wireless display verification passcode from Bytello Share .
3	Date and Time	Displays the current date and time. Adjust the settings in Settings menu. Refer to page 58.
4	Status Bar Indicators	Displays the connections.
5	App Shortcuts	Accesses the Finder app, Meetboard app, Apps screen, and Bytello Share app.

Note:

- ◆ In Android mode, if no touch activity is detected within 15 minutes, the device will prompt to shut down for energy saving purposes. Refer to page 59. If no action is taken, the device will shut down automatically after 10 seconds.

USING THE SYSTEM

4.2 Using the Assistive Menu

The Assistive menu can be accessed on either sides of the interactive display by touching . For more convenient access, you can touch and hold on the Assistive menu icon to slide it up or down. Assistive menu icons are always visible on the screen regardless of your location in the user interface.

To use the Assistive menu, do the following:

- 1 Touch the  icon on either sides of the interactive display.

The Assistive menu opens.

- 2 Touch any of the following Assistive menu items:

- **Back** : Returns to the previous screen.

Note:

- ◆ Back function is available only if the source is Android.

- **Home** : Accesses the Home screen.

- **Recently Used Apps** : Manages recently used apps. Do any of the following:

- To reopen: Touch the app.

- To close: Swipe the app to the left or to the right or touch .

- To close all apps: Touch **Clean All**.

Note:

- ◆ Recently used apps function is available only if the source is Android.

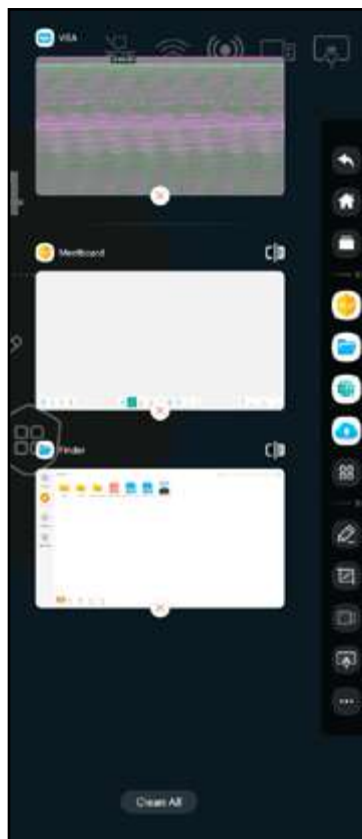

USING THE SYSTEM

- **App Shortcuts:** Quick access for common apps. Touch any of the following icons: 📄 opens **Meetboard**, 📁 opens **Finder**, 🌐 opens web browser, and ☁ opens cloud storage (requires user authentication at first log in). To access more apps, touch 📱.
- **Tools:** The interactive display features several tools, such as screen capture, screen recording, and more. Touch any of the following icons: 🖋 **Annotations** to enter writing mode, 📐 **Crop** to open screen capture tool, 📹 **Record** to open screen recording tool, ⚙ **Menu** to open General settings menu. To access more tools, touch ⋮. Then touch any of the following icons: ⌚ **Stopwatch**, 🎓 **AirClass** to start online class, 🔦 **Spotlight** to emphasize an area on the screen, ❄ **Freeze** to freeze the screen, ⌚ **Spotlight** to count down time for events, or 🔒 **ScreenLock** to prevent access to the interactive display.
- **Annotation App** 🖋: Opens the **Annotation** app and enters writing mode.

Note:



- ◆ The **Annotation** app cannot be accessed while using the **Meetboard** app.
- ◆ To rearrange tool icons in the Assistive menu, touch ⋮ > **Edit**. Touch - next to the icon you want to remove and then touch + next to the icon you want to add. You can add up to 4 tool shortcuts to the Assistive menu.



- 3 To close the Assistive menu, touch anywhere on the screen outside the Assistive menu.

USING THE SYSTEM

4.3 On Screen Display (OSD) Menu

#	Menu Navigation	Operation	
		Remote Control	Touch Gesture
1	<p>Displays the Audio menu.</p> 	<p>Press the Menu button.</p>	<p>Swipe the screen from the bottom to up and then touch ***.</p>
2	<p>Enters the submenu.</p> 	<ol style="list-style-type: none"> 1 Press the ◀ or ▶ button to select the main menu item. 2 Press the ▼ button to enter the submenu. 3 Press the ◀, ▶, ▲, or ▼ button to select the submenu item. 4 Press the Enter button to enter the adjustment mode. 	<ol style="list-style-type: none"> 1 Touch the main menu item. 2 Touch the submenu item to select it.
3	<p>Adjusts the settings. For example:</p> 	<p>Press the Enter button to change the setting or press the ◀ or ▶ button to adjust the value.</p>	<p>Touch the setting or drag the ● clockwise or counterclockwise in an arc trajectory to adjust the item value.</p>
4	<p>Closes the OSD window.</p>	<p>Wait until the OSD menu disappears automatically (around 10 seconds) or press the Back button (repeatedly if necessary).</p>	<p>Touch anywhere on the screen outside the OSD menu.</p>

USING THE SYSTEM

When settings are modified, all changes are saved when the user does the following:

- Proceeds to the another menu.
- Exits the OSD menu.
- Waits for the OSD menu to disappear.

Note:

- ◆ Availability of some menu items depend on the input source signal or selected setting. If the menu is not available, it is disabled and grayed out.

4.3.1 OSD Menu Tree

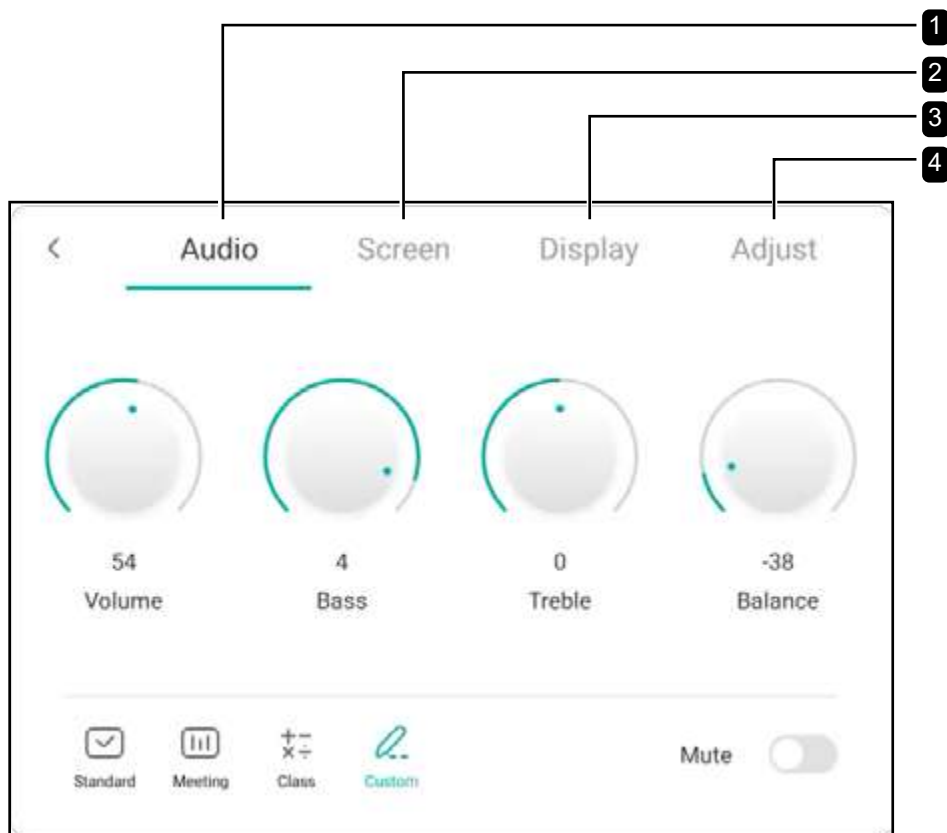

Main Menu	Submenu	Remarks
1. Audio	<ul style="list-style-type: none"> • Volume • Bass • Treble • Balance • Mute 	See page 52.

USING THE SYSTEM

Main Menu	Submenu	Remarks
2. Screen	<ul style="list-style-type: none"> • 4:3 • 16:9 • Full • Anti-Burn-in™ • Eye Care • Auto Light • Power Saving • DCR 	See page 53.
3. Display	<ul style="list-style-type: none"> • Brightness • Contrast • Hue • Sharpness 	See page 55.
4. Adjust Note: This menu is only supported if the input source is VGA.	<ul style="list-style-type: none"> • H Position • V Position • Clock • Phase • AUTO 	See page 56.

4.4 Adjusting the Interactive Display

4.4.1 Audio Menu



- 1 Press the **Menu** button.
The Audio menu opens automatically.
- 2 Press the ▼ button to enter submenu.
- 3 Press the ◀, ▶, ▲, or ▼ button to select the submenu item.

Item	Function	Operation	Range
Predefined Audio Modes	Selects the predefined audio mode.	Press the Enter button to select the setting.	Standard Meeting Class Custom

USING THE SYSTEM

Item	Function	Operation	Range
Volume	Adjusts the volume.	<ol style="list-style-type: none"> 1 Press the Enter button to select the setting. 2 Press the ◀ or ▶ button to adjust the value. 	0 to 100
Bass	Adjusts to increase or decrease lower-pitched sounds. Note: This item can be adjusted only if the Predefined Audio Mode is set to Custom .		-5 to 5
Treble	Adjusts to increase or decrease higher-pitched sounds. Note: This item can be adjusted only if the Predefined Audio Mode is set to Custom .		-5 to 5
Balance	Adjusts to emphasise the left (L) or right (R) audio output balance.		-50 to 50
Mute	Mutes the volume. Note: If the sound is muted then all the Audio menu items become unavailable except for the Volume .	Press the Enter button.	On Off

4.4.2 Screen Menu

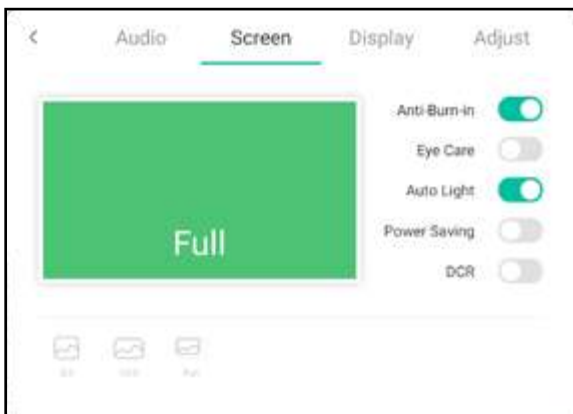

- 1 Press the **Menu** button.
The Audio menu opens automatically.
- 2 Press the ◀ or ▶ button to select **Screen** menu.
- 3 Press the ▼ button to enter submenu.
- 4 Press the ◀, ▶, ▲, or ▼ button to select the submenu item.

USING THE SYSTEM

Item	Function	Operation	Range
Anti-Burn-in™	Prevents image retention.	Press the Enter button.	On Off
Eye Care	Enables or disables the blue light filter function. When enabled, it decreases the amount of blue light displayed on the screen, ensuring users a comfortable viewing experience by reducing eyestrain after long periods of use.		On Off
Auto Light	Adjusts the backlight of the interactive display automatically depending on the amount of ambient light.		On Off
Power Saving	Enables or disables power saving mode. When the interactive display turns into power saving mode, the screen turns black and the Power button LED indicator starts to flash red and white alternatively. Note: The Power Saving function depends on standby settings configured in System Settings > Power Settings menu.		On Off
DCR (Dynamic Contrast Ratio)	Activates DCR. This feature provides automatic adjustment of picture brightness and contrast at high speed and dynamic contrast range, such as when watching movies.	Press the Enter button.	On Off
4:3	Sets the aspect ratio to 4:3.		N/A
16:9	Sets the aspect ratio to 16:9.		N/A
Full	Sets the aspect ratio to full screen.		N/A

USING THE SYSTEM

4.4.3 Display Menu



- 1 Press the **Menu** button.
The Audio menu opens automatically.
- 2 Press the ◀ or ▶ button to select **Display** menu.
- 3 Press the ▼ button to enter submenu.
- 4 Press the ◀, ▶, ▲, or ▼ button to select the submenu item.

Item	Function	Operation	Range
Predefined Display Modes	Selects the predefined display mode.	Press the Enter button.	Standard Bright Soft Custom
Predefined Colour Temperature Modes	Selects the predefined colour temperature mode.		Standard Cold Warm
Brightness	Adjusts the luminance of the screen image. Note: This item can be adjusted only if the Predefined Display Mode is set to Custom .	<ol style="list-style-type: none"> 1 Press the Enter button to select the setting. 2 Press the ◀ or ▶ button to adjust the value. 	0 to 100
Contrast	Adjusts the difference between the black level and the white level. Note: This item can be adjusted only if the Predefined Display Mode is set to Custom .	<ol style="list-style-type: none"> 1 Press the Enter button to select the setting. 2 Press the ◀ or ▶ button to adjust the value. 	0 to 100
Hue	Adjusts the colour balance of red and green. Note: This item cannot be adjusted.	N/A	50
Sharpness	Adjusts the clarity and focus of the screen image. Note: This item cannot be adjusted.		50

USING THE SYSTEM



4.4.4 Adjust Menu

Note:

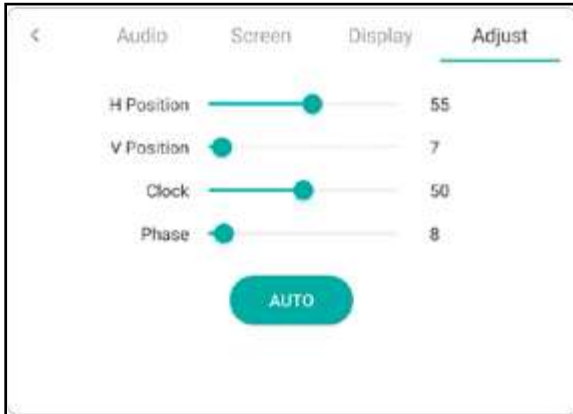
- ◆ Adjust menu items are only available if the input source is VGA.

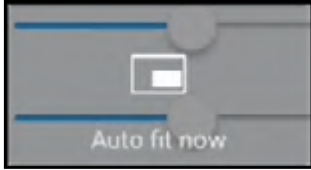

- 1 Press the **Menu** button.
The Audio menu opens automatically.
- 2 Press the ◀ or ▶ button to select **Adjust** menu.
- 3 Press the ▼ button to enter submenu.
- 4 Press the ▲ or ▼ button to select the submenu item.



Item	Function	Operation	Range
H Position	Moves the image to the right or to the left.	<ol style="list-style-type: none"> 1 Press the Enter button to enter the adjustment mode. 2 Press the ◀ or ▶ button to adjust the value. 	0 to 100
V Position	Moves the image up or down.		0 to 100
Clock	Adjusts the width of the image.		0 to 100
Phase	Adjusts to improve the focus, clarity, and stability of the image.		0 to 100
AUTO	<p>Adjusts the screen image automatically.</p> <p>Note: During the auto adjustment, you will see the progress notification followed by the procedure is complete notifications.</p> <p>Auto Fit in Progress</p>  <p>Procedure is Complete</p> 	Press the Enter button.	N/A

USING THE SYSTEM

4.5 Configuring System Settings

In Settings menu, you can configure various system settings.

To access the Settings menu, do the following:

- 1 On the Home screen, touch  > .

The Settings menu opens.

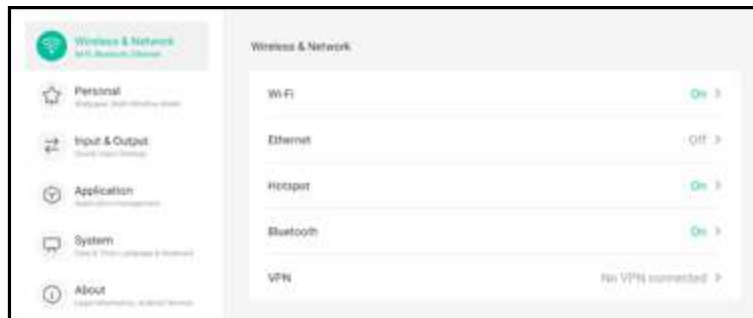

- 2 Configure any of the following settings:

Wireless & Network:

- **Wi-Fi:** Connects to an available wireless access point. Enter the access password if prompted.
- **Ethernet:** Connects to LAN through a wired connection. Configures IP settings manually (Obtain IP Address Automatically is disabled) or automatically (Obtain IP Address Automatically is enabled).
- **Hotspot:** Shares interactive display's Internet connection to other devices through hotspot and configures hotspot DHCP settings (if necessary).
- **Bluetooth:** Connects to other Bluetooth devices.
- **VPN:** Sets up and manages virtual private networks for safe and secure online communication.

Personal:

- **Wallpaper:** Sets the Home screen wallpaper.
- **Swipe up options at the bottom:** Sets the action that takes place when the screen is swiped up from the bottom. Either opens the General settings menu or displays the Assistive menu icons on the bottom of the screen.
- **Multi-Window Mode:** Displays more than one app window at the same time. Enabling multi-window mode consumes more energy.
- **SystemBar Icon Name:** Enables or disables displaying Assistive menu icon names.

Input & Output:

- **Sound > Touch Sounds:** If enabled, plays audio feedback when touching items on the screen.
- **Sounds > Sound Output Settings:** Selects the sound output device.
- **Input Settings > Input Naming Settings:** Renames input sources.
- **External Source Display Settings > HDMI OUT Format:** Selects the HDMI OUT frequency and resolution.
- **External Source Display Settings > Type-C Format:** Selects the Type-C format.

USING THE SYSTEM

Application:

- Manages apps that are installed to the interactive display. You can enable or disable the app, force stop it, enable or disable notifications from the app, manage storage, open the app by default, monitor memory usage, and modify advanced settings.

System:

- **Date & Time:** Configures date and time settings.
- **Language & Keyboard:** Sets system language and configures keyboard settings.
- **Password:** Sets lock screen password and advanced settings password.
- **Power Settings:** Configures power settings. Refer to 59.
- **Anti-Burn-in™:** Prevents the display from “burn-in” or “afterimage” symptoms when the display is not being in use for a period of time. Select the time interval for executing the Anti-Burn-in™ function.
- **Email:** Configures email settings. For example for sending drawings from **Meetboard** to your email.
- **Storage:** Manages the internal storage.
- **System Update:** Updates the system when a new version is available.
- **Security:** Configures credential storage settings.
- **Advanced Settings:** Configures advanced settings. To access the Advanced Settings, you need to set the Advanced Lock Password in the Security menu. Then enable or disable installing apps from third-party app stores, enable or disable accessing the USB drive, SAMBA service, and reset the settings to the factory defaults.

About:

- Read legal information, view module number, Android and Kernel version, build number, and access developer options.

- 3 To close the Settings menu, touch anywhere on the screen outside the Settings menu.

USING THE SYSTEM

4.6 Power Settings

In the Power Setting menu, you can configure booting options, system power options, and schedule boot-time.

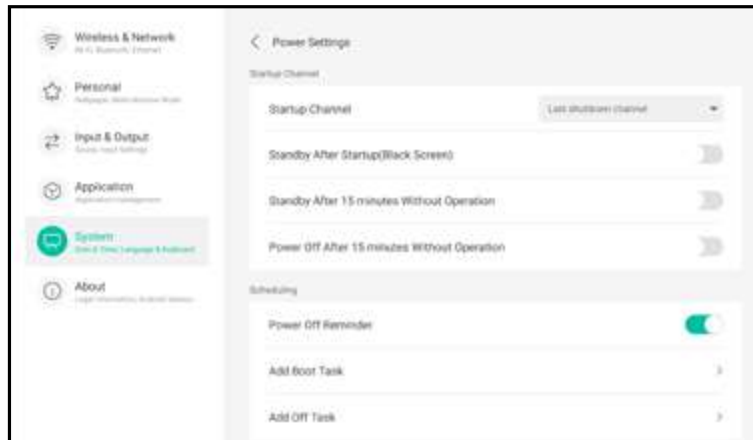

4.6.1 Booting Options

In the Startup Channel menu, set the default source at boot up and configure system standby setting.

4.6.1.1 Startup channel

Select the default startup channel among:

- **Last shutdown channel:** Input source is the same as at last boot.
- **Meetboard/HDMI1/HDMI2/HDMI3/Type-C/VGA:** Startup channel is **Meetboard**, **HDMI1**, **HDMI2**, **HDMI3**, **Type-C**, or **VGA** respectively.

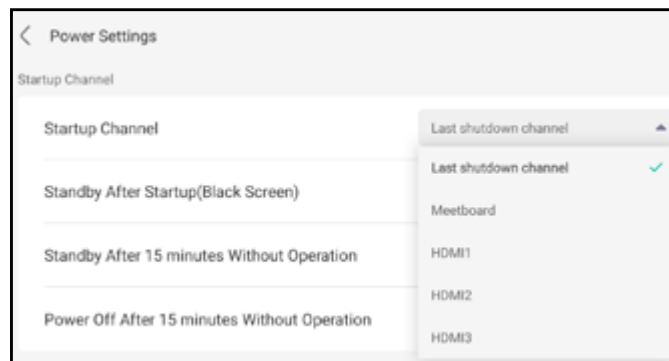

4.6.1.2 Standby setting

To enable the interactive display to standby after startup (black screen), standby after 15 minutes without operation, or power off after 15 minutes without operation, slide the respective option to on.

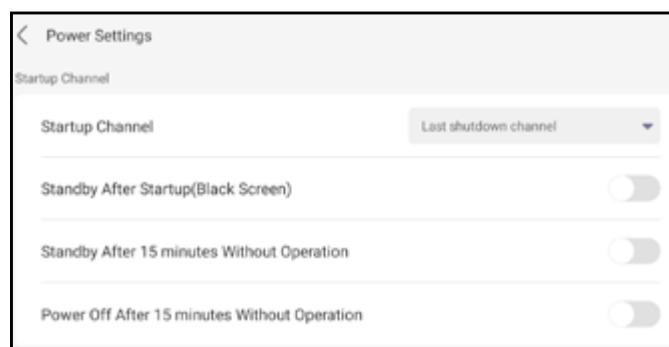

USING THE SYSTEM

Note:

- ◆ In standby mode, the **POWER** button is flashing red and white alternatively.

4.6.2 Scheduling

In the Scheduling menu, enable or disable displaying power off reminder before shutting down the system and schedule boot and off tasks.

- **Add Boot Task:** Adds a boot schedule. Select the time and day.

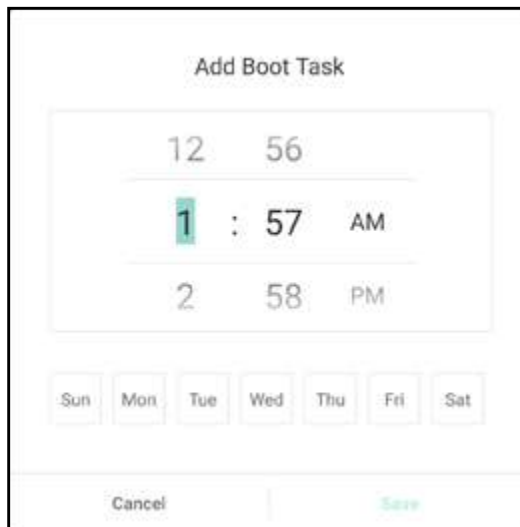

The screenshot shows a dialog box titled "Add Boot Task". It features a time selection interface with three rows: "12 56", "1 : 57 AM" (where the "1" is highlighted in green), and "2 58 PM". Below the time selection is a row of seven buttons representing the days of the week: "Sun", "Mon", "Tue", "Wed", "Thu", "Fri", and "Sat". At the bottom of the dialog are two buttons: "Cancel" and "Save".

- **Add Off Task:** Adds a power off schedule. Select the time and day.

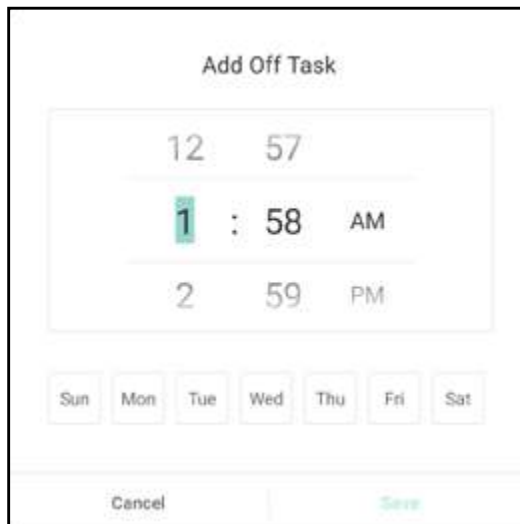

The screenshot shows a dialog box titled "Add Off Task". It features a time selection interface with three rows: "12 57", "1 : 58 AM" (where the "1" is highlighted in green), and "2 59 PM". Below the time selection is a row of seven buttons representing the days of the week: "Sun", "Mon", "Tue", "Wed", "Thu", "Fri", and "Sat". At the bottom of the dialog are two buttons: "Cancel" and "Save".

CHAPTER 5: USING THE APPS

5.1 Accessing Apps

Some apps, such as **Meetboard**, **Finder**, and **Bytello Share** are accessible directly from the Home screen. Other apps that are installed to the system can be accessed through the Apps screen.

To access the Apps screen, do the following:

- 1 On the Home screen, touch .

The Apps screen opens.





- 2 On the Apps screen, touch any of the following apps:

-  **Browser:** Opens the web browser for surfing the Internet.

Note:

◆ Make sure your interactive display is connected to the Internet.

-  **Bytello Share:** Mirrors the screen of your portable device to the interactive display and more. Refer to 68.

-  **Cloud Drive:** Configures cloud storage access settings. These settings may be prompted also in other apps that require cloud connection. Refer to 67.

-  **Finder:** Manages your files. Refer to page 66.

-  **Keeper:** Optimises system performance easily.

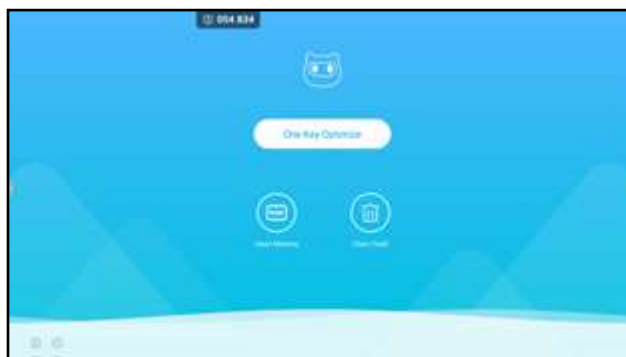

-  **Meetboard:** Opens a whiteboard application for brainstorming and more. Refer to page 62.

-  **Palette:** Opens a drawing board with mixing colour feature.

-  **Settings:** Views and configures system settings. Refer to page 57.

-  **Visualizer:** Enables to stream live images coming from the document camera onto your portable device. Make sure the document camera is connected to the interactive display.

USING THE APPS

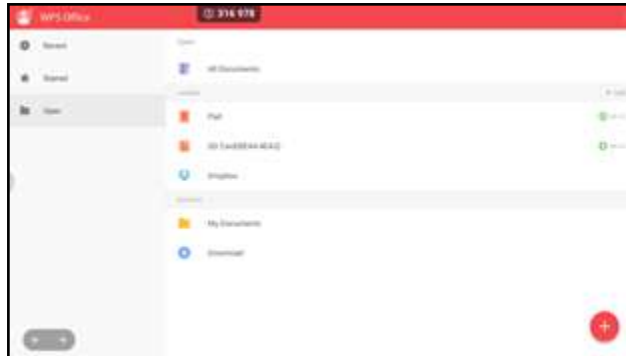

-  **WPS Office**: Views PDF files, opens and edits different files including Microsoft Word, PowerPoint, Excel, and text files. You can also create new spreadsheets, presentations, memos, and documents.



5.2 Meetboard Apps

Meetboard is an interactive app that enables you to make drawings for demonstrating ideas on the display. The drawings can be saved to the device memory, connected portable disk, or cloud storage, or easily shared via QR code or email.

To use the **Meetboard** app, do the following:

- 1 Touch the  icon on the Home screen or the  icon on the Apps screen.
The **Meetboard** app opens.



- 2 Draw directly on the board with the default settings for colour, marker width, pen type, and background colour or touch any of the following icons to modify the default settings:

-  **Pen**: Sets up the colour, type, and width for the pen while handwriting or while using the touch pen.

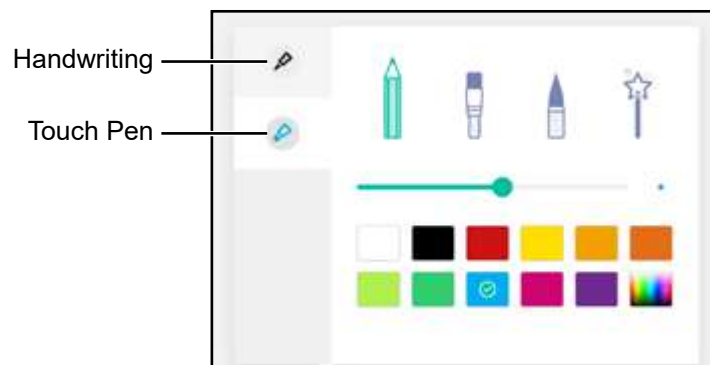



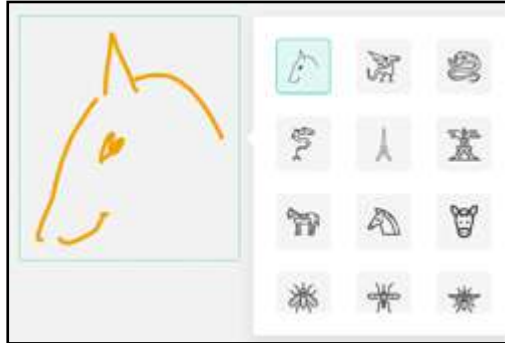

USING THE APPS

Note:

- ◆ If the pen type is  then the **Meetboard** tries to recognise your image automatically while you are drawing it on the writing board and provides image hints. If your image matches with the preset image, touch it to replace your image with the preset image. For example:



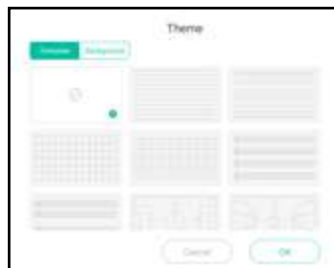

- Touch  **More**: Adds an interactive ruler, 2D or 3D shape, customisable table, mind map, or preset grid to the writing board.
- Touch  **Sticky-Notes**: Adds a note to the writing board.
- Touch  **Menu** >  **Theme**: Adds a preset template, background colour/image to your drawing. To set a preset template or background colour, touch **Template** tab or **Background** tab respectively. Select the template or your preferred background colour and touch **OK**. To select an image, tap Background > Images >  and select your preferred image. To cancel editing the theme, touch **Cancel**.

Template selection



Colour/image selection



- Touch  **Menu** >  **Import**: Imports an IMG, PDF, or SVG file to the writing board. After importing the object, you can crop it, vectorise (if supported), flip, rearrange on the screen, clone, and delete.











USING THE APPS

3 To control the drawing on the board, use the following actions:

-  **Select**: Selects objects on the writing board. After selecting the object or part of it, you can change its colour, detect a character (SmartWrite), search similar objects online, flip it, rearrange on the screen, clone, or delete it.









- **Erase**: Touch  **Eraser** and select the eraser size. Then put your fist or palm on the board and move to the area that needs to be erased. To clear the entire writing board, touch  **Clean All**.
-  **Preview**: Provides a preview of the writing board.
-  **Undo**: Reverses the most recent action on the writing board.
-  **Redo**: Restores the most recent action on the writing board.
-  **Add**: Adds a new page.
-  **Previous**: Moves to the previous page if there are multiple pages in the file.
-  **Next**: Moves to the next page if there are multiple pages in the file.

Note:

- ◆ Touch on the page count () to thumbnail all pages and remove unnecessary pages.



4 After the drawing is finalised, touch any of the following:

-  **Menu** >  **Save**: Select a storage and path where to save the drawing and then name the drawing.
-  **Menu** >  **Export**: Export the drawing as IMG, PDF, SVG, or IWB. You are prompted to select the storage, path, and name for the drawing.
-  **Menu** >  **Cloud Storage**: Save the drawing to your cloud storage either **Google Drive** or **OneDrive**. If you have not configured the cloud storage access yet, you are prompted to enter your account information.

Note:

- ◆ To save to the cloud storage, make sure the interactive display is connected to the Internet.

USING THE APPS

-  **Menu** >  **Send Email**: Emails the drawing. If you are sending the drawing by email for the first time, you are prompted to configure your email settings. Follow the on-screen instructions to complete the configuration.







After all settings are configured, return to the **Meetboard** app and send the drawing by email. The drawing is added as an attachment.



Note:



- ◆ To send an email, make sure the interactive display is connected to the Internet.
-  **Share**: Displays a QR code on the screen that directs to the online location where the drawing can be downloaded to any portable device that is connected to the same Wi-Fi with the interactive display.



-  **Menu** >  **Open**: Opens previously saved file from the storage device. You are prompted to select a storage device and the path where the file is saved.
-  **Menu** >  **New**: Opens a new writing board.

Note:

- ◆ To list and open previously saved writing boards or create a new writing board, touch  **New**.
- : Exits the **Meetboard** app. You are prompted to confirm saving modifications and exit the **Meetboard**.

- 5 To configure the **Meetboard** settings, such as eraser mode, multi-finger writing, automatic brightness, and customise toolbars, touch  **Menu** >  **Settings**.

USING THE APPS

5.3 Annotation Tool

Annotation is an app that provides a more fluid discussion of visual images by annotating anywhere on the display.

Note:



- ◆ The **Annotation** app cannot be accessed while using the **Meetboard** app.

To use the **Annotation** app, do the following:











- 1 In Assistive menu, touch .

The system enters to the writing mode and displays the **Annotation** control bar on the screen.



- 2 Draw directly on the screen with the default pen thickness and colour. To change the thickness and colour, touch and hold the  **Pen** or  **Brush** icon and do the modifications.

- 3 After the drawing is finalised, touch any of the following:

-  **Clean**: Erases the drawing. To erase part of the drawing, use your fist or palm.
 -  **Save**: Saves the drawing by default to the Storage > Meetboard > Annotations folder. You can access it using  **Finder**. If you want to insert the drawing to the **Meetboard**, share by QR code, or save to the cloud storage, save the drawing first and then touch  **More** >  **Insert**/  **Share**/  **Cloud** respectively.
 -  **Select**: Select the location where to save the image in the  **More** menu.
- 4 To exit the **Annotation** app, touch  **Close**.

5.4 Finder App





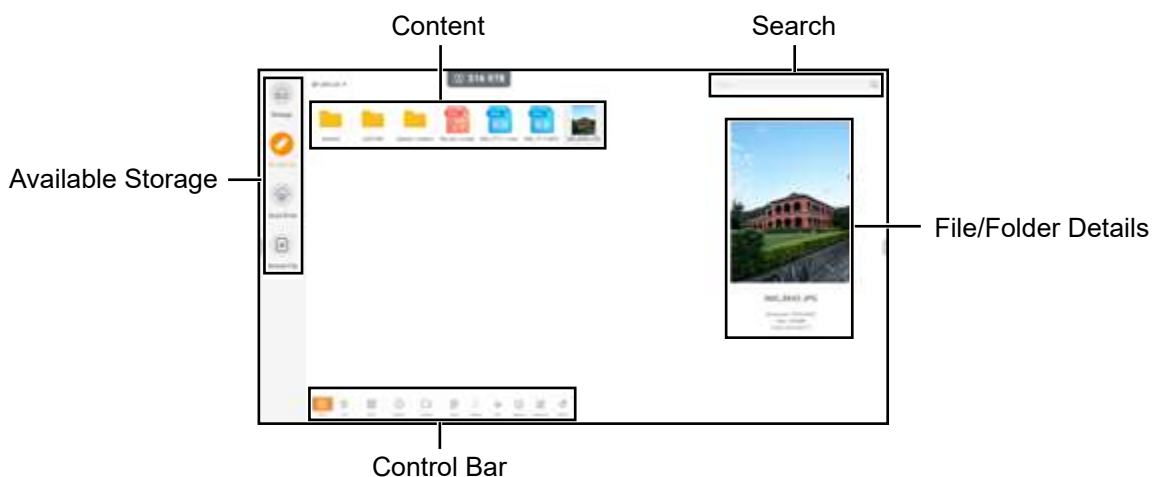







Finder enables you to manage files that are saved in the internal memory, connected external storages, or cloud storage.

An example **Finder** Home screen is as follows:



USING THE APPS



To start using the **Finder** app, do the following:

- 1 On the Home screen, touch  or on the Apps screen, touch .
The **Finder** Home screen opens.
- 2 Touch any of the following:
 - Storage that you want to manage.
 -  **Grid/List**: Displays the content as grid or as list.
 -  **Sort**: Sorts the content by name (ascending or descending), time, size, or type.
 -  **Select**: Selects items for copy ( **Copy**), paste ( **Paste**), cut ( **Cut**), deletion ( **Delete**), rename ( **Rename**) (only available for individual item), or creating a shortcut/sending to another storage device  **Send**. While in selection mode or paste mode, touch  **Close** to close the selection or paste mode.
 -  **Create**: Adds a folder.

5.5 Cloud Drive

To access your cloud storage from various apps installed on the interactive display, you are prompted to enter user credentials at first log in.

To access your cloud storage from the interactive display, do the following:

- 1 On the Home screen, touch  >  or Assistive menu > .
- 2 Touch **Add Account**.



- 3 Select the drive type. Touch either **Google Drive** if you have storage account in Google or touch **OneDrive** if you have storage account in Microsoft.



USING THE APPS

- 4 Enter your login credentials and follow the on-screen instructions to complete the authentication process.

Google Drive Login



OneDrive Login



5.6 Bytello Share App

With the **Bytello Share** app, you can mirror the display's screen on your portable device for hands-on annotation, mirror the screen of your device on the display, or use your device as a remote control for the display.

Bytello Share is accessible either by downloading the sender app to your portable device or by sharing the screen via **Airplay**, **Chromecast**, or **Miracast**.



Note:

- ◆ To share the screen via **Airplay**, **Chromecast**, or **Miracast**, please refer to the "How to share screen without client?" section in the **Bytello Share** User Guide. The User Guide can be accessed from the launcher screen.



To download the **Bytello Share** sender app, do the following:

Note:

- ◆ **Bytello Share** supports sender app version 5 and above. Alternatively, you can connect to the interactive display through service discovery.
- 1 Make sure your portable device and the interactive display are connected to the same wireless network.
 - 2 On the Home screen, touch  or on the Apps screen, touch .
- The **Bytello Share** launcher screen opens.
- 3 On the launcher screen, touch **User Guide** ().
 - 4 Scan the QR code or enter the URL to the browser to access the **Bytello Share** sender download page and then install the sender to your portable device.

USING THE APPS

- 5 Open the **Bytello Share** app on your portable device and enter the remote code that is visible on the Home screen and launcher screen.



After the connection is established, the following screen opens on your portable device:

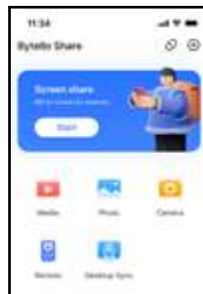

- 6 Touch any of the following:



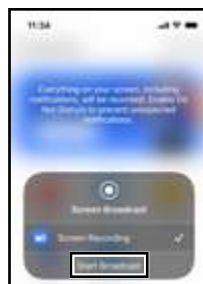



- **Screen share > Start:** Shares your portable device's screen to the interactive display. For example, in iOS touch **Start Broadcast** to start sharing the screen.



- **Media:** Plays media files from your portable device on the screen of the interactive display.
- **Photo:** Displays photos from your portable device on the screen of the interactive display.
- **Camera:** Mirrors your camera screen to the interactive display.
- **Remote:** Enables you to use your portable display as a remote mouse for operating the interactive display.
- **Desktop Sync:** Mirrors the fully functional interactive display screen on your portable device.



USING THE APPS

Note:

- ◆ To configure **Bytello Share** settings, such as access permissions, screen sharing without client, general settings including device name, starting the app on boot, code refresh rate, and more, touch **Menu**  >  **Settings** on the launcher screen.
- ◆ To manage the connected devices, touch **Devices (#)**  on the launcher screen. Then touch any of the following icons:
 - : Initiates the device to start screen casting.
 - : Sends files from the interactive display to the device.
 - : Authorizes the device to manage other senders and approve requests from them.
 - : Disconnects the device.

CHAPTER 6: APPENDIX

6.1 Warning Messages

Warning Messages	Cause	Solution
	The resolution or the refresh rate of the graphics card of the computer is set too high.	<ul style="list-style-type: none"> Change the resolution or the refresh rate of the graphics card.
	The interactive display cannot detect the input source signal.	<ul style="list-style-type: none"> Check if the input source is turned ON. Check if the signal cable is properly connected. Check if any pin inside the cable connector is twisted or broken.

6.2 Supported Media Formats

Video Format

File Extensions	Codec			
	Video	Audio	Maximum Transmit Ratio	
.3gp/3GP2	mpeg1/2	Mpeg1/2 Layer1/2/3, AACLC, vorbis, LPCM, AMR-NB	Spec: Max Solution: 1920 x 1080 60 Fps, 80 Mbps	
	Mpeg-4			
	H.263		Spec: Max Solution: 8192 x 4320 60 Fps, 200 Mbps	
	H.264			
	Mjpeg			Spec: Max Solution: 1920 x 1080 30 Fps, 30 Mbps
	vp8			Spec: Max Solution: 1920 x 1080 60 Fps, 60 Mbps
.asf/asx	mpeg1/2	Mpeg1/2 Layer1/2/3, AACLC, vorbis, LPCM, AMR-NB	Spec: Max Solution: 1920 x 1080 60 Fps, 80 Mbps	
	Mpeg-4			
	H.263		Spec: Max Solution: 8192 x 4320 60 Fps, 200 Mbps	
	H.264			
.avi	H.265	Mpeg1/2 Layer1/2/3, AACLC, vorbis, LPCM, AMR-NB	Spec: Max Solution: 8192 x 4320 60 Fps, 200 Mbps	
	mpeg1/2		Spec: Max Solution: 1920 x 1080 60 Fps, 80 Mbps	
	Mpeg-4		Spec: Max Solution: 8192 x 4320 60 Fps, 200 Mbps	
	H.263			
	H.264		Spec: Max Solution: 1920 x 1080 30 Fps, 30 Mbps	
	Mjpeg		Spec: Max Solution: 1920 x 1080 30 Fps, 30 Mbps	
	vp8		Spec: Max Solution: 1920 x 1080 60 Fps, 60 Mbps	

APPENDIX

File Extensions	Codec		
	Video	Audio	Maximum Transmit Ratio
.dat	mpeg1/2	Mpeg1/2 Layer1/2/3, AACLC, LPCM	Spec: Max Solution: 1920 x 1080 60 Fps, 80 Mbps
	Mpeg-4		Spec: Max Solution: 8192 x 4320 60 Fps, 200 Mbps
	H.264		
.flv	H.265	Mpeg1/2 Layer1/2/3, AACLC, LPCM	Spec: Max Solution: 8192 x 4320 60 Fps, 200 Mbps
	Mpeg-4		Spec: Max Solution: 1920 x 1080 60 Fps, 80 Mbps
	H.263		Spec: Max Solution: 8192 x 4320 60 Fps, 200 Mbps
	H.264		
	Mjpeg		Spec: Max Solution: 1920 x 1080 30 Fps, 30 Mbps
	vp8		Spec: Max Solution: 1920 x 1080 60 Fps, 60 Mbps
.mkv	vp9	Mpeg1/2 Layer1/2/3, AACLC, LPCM, opus	Spec: Max Solution: 8192 x 4320 30 Fps, 60 Mbps
	H.265		Spec: Max Solution: 8192 x 4320 60 Fps, 200 Mbps
	mpeg1/2		Spec: Max Solution: 1920 x 1080 60 Fps, 80 Mbps
	Mpeg-4		Spec: Max Solution: 3840 x 2160 30 Fps, 160 Mbps
	H.264		
	Mjpeg		Spec: Max Solution: 1920 x 1080 30 Fps, 30 Mbps
	vp8		Spec: Max Solution: 1920 x 1080 60 Fps, 60 Mbps
.mov	H.265	Mpeg1/2 Layer1/2/3, AACLC, vorbis, LPCM, AMR-NB	Spec: Max Solution: 8192 x 4320 60 Fps, 200 Mbps
	mpeg1/2		Spec: Max Solution: 1920 x 1080 60 Fps, 80 Mbps
	Mpeg-4		
	H.263		Spec: Max Solution: 8192 x 4320 60 Fps, 200 Mbps
	H.264		
	Mjpeg		
	vp8		Spec: Max Solution: 1920 x 1080 60 Fps, 60 Mbps
.mp4	H.265	Mpeg1/2 Layer1/2/3, AACLC, vorbis, LPCM, AMR-NB	Spec: Max Solution: 8192 x 4320 60 Fps, 200 Mbps
	mpeg1/2		Spec: Max Solution: 1920 x 1080 60 Fps, 80 Mbps
	Mpeg-4		
	H.263		Spec: Max Solution: 8192 x 4320 60 Fps, 200 Mbps
	H.264		
	Mjpeg		
	vp8		Spec: Max Solution: 1920 x 1080 60 Fps, 60 Mbps

APPENDIX

File Extensions	Codec		
	Video	Audio	Maximum Transmit Ratio
.VOB	mpeg1/2	Mpeg1/2 Layer1/2/3, AACLC, LPCM	Spec: Max Solution: 1920 x 1080 60 Fps, 80 Mbps
	Mpeg-4		Spec: Max Solution: 1920 x 1080 60 Fps, 80 Mbps
.mpg/.mpeg	mpeg1/2	Mpeg1/2 Layer1/2/3, AACLC, LPCM	Spec: Max Solution: 1920 x 1080 60 Fps, 80 Mbps
	Mpeg-4		Spec: Max Solution: 8192 x 4320 60 Fps, 200 Mbps
	H.264		
.webm	vp9	Mpeg1/2 Layer1/2/3, AACLC, LPCM, opus	Spec: Max Solution: 8192 x 4320 30 Fps, 60 Mbps
	H.265		Spec: Max Solution: 8192 x 4320 60 Fps, 200 Mbps
	mpeg1/2		Spec: Max Solution: 1920 x 1080 60 Fps, 80 Mbps
	Mpeg-4		Spec: Max Solution: 8192 x 4320 60 Fps, 200 Mbps
	H.264		
	Mjpeg		Spec: Max Solution: 1920 x 1080 30 Fps, 30 Mbps
	vp8		Spec: Max Solution: 1920 x 1080 60 Fps, 60 Mbps
.ts	H.265	Mpeg1/2 Layer1/2/3, AACLC, LPCM	Spec: Max Solution: 8192 x 4320 60 Fps, 200 Mbps
	mpeg1/2		Spec: Max Solution: 1920 x 1080 60 Fps, 80 Mbps
	Mpeg-4		Spec: Max Solution: 8192 x 4320 60 Fps, 200 Mbps
	H.264		

Audio Format

File Extensions	Format	Audio Codec	Supported Range
.aac	AAC	AAC-LC	Sample Rate: 8K-48 KHz
			Bit Rate: 16K-576 Kbps
.ape	Monkey's Audio	Monkey's Audio	Sample Rate: 32, 44.1, 48 KHz
			Bit Rate: 500 Kbps-1.5 Mbps
.flac	FLAC	FLAC	Sample Rate: 8K-192 KHz
			Bit Rate: 128-2304 Kbps
.amr	AMR-NB	AMR-NB	Sample Rate: 8 KHz
			Bit Rate: 4.75-12.2 Kbps
.opus	OPUS	OPUS	Sample Rate: 8K-48 KHz
			Bit Rate: 32K-9612 Kbps
.mp3	MPEG Audio Layer3	MPEG1/2 layer3	Sample Rate: 8K-48 KHz
			Bit Rate: 8-320 Kbps
.ogg	Vorbis	Vorbis	Sample Rate: 6K-48 KHz
			Bit Rate: 8-500 Kbps
.wav	WAV	LPCM	Sample Rate: 6K-192 KHz

APPENDIX

Image Format

File Extensions	Format	Supported Range	Remark
.bmp	BMP	9600 x 6400	The limitation of max resolution depends on DRAM size
.gif	GIF	6400 x 4800	
.jpeg/jpg	JPEG	Base-line 15360 x 8640	
		Progressive 1024 x 768	
.png	PNG	9600 x 6400	

Note:

- ◆ Sound or video may not work if the contents have a standard bit rate/frame rate above the compatible Frame/sec listed in the table above.
- ◆ Video content with a Bit rate or Frame rate larger than the rate specified in the table above can cause choppy video during playback.

6.3 Supported Resolution

Computer Mode

Standard Resolution	Resolution		Refresh Rate
	Horizontal	Vertical	
IBM VGA	720	400	70
IBM VGA	640	480	60
VESA	800	600	56
VESA	800	600	60
VESA	1024	768	60
VESA	1280	720	60
VESA	1280	800	60
VESA	1280	960	60
VESA	1280	1024	60
VESA	1680	1050	60
VESA	1920	1080	60
4K2K (HDMI, Type-C)	3840	2160	60

APPENDIX

Video Mode

Standard Resolution	Resolution		Refresh Rate
	Horizontal	Vertical	
EDTV (16:9)	720	480	60i
EDTV (16:9)	720	480	60
EDTV (4:3)	720	480	60i
EDTV (4:3)	720	480	60
EDTV	720	576	50i
EDTV	720	576	50
HDTV	1280	720	50
EDTV	1280	720	60
HDTV	1920	1080	50i
HDTV	1920	1080	50
HDTV	1920	1080	60i
HDTV	1920	1080	60
4K2K (HDMI, Type-C)	3840	2160	60

General guidelines:



- The PC text quality is optimum in HD 1080 mode (1920 x 1080, 60 Hz).
- Your PC display screen might appear different depending on the manufacturer (and your particular version of Windows).
- Check your PC instruction book for information about connecting your PC to a display.
- When horizontal synchronous signals seem irregular in RGB mode, check PC standby mode or cable connections.
- The display settings table complies to the IBM/VESA standards, and based on the analog input.
- The best timing for the vertical frequency to each mode is 60 Hz.

APPENDIX

6.4 Troubleshooting

Symptom	Possible Cause	Remedy
No picture is displayed	<ul style="list-style-type: none"> The power cord has been disconnected. The main power switch on the bottom of the display is not switched on. The selected input has no connection. The display is in standby mode. 	<ol style="list-style-type: none"> 1 Plug in the power cord. 2 Make sure the power switch is switched on. 3 Connect a signal connection to the display.
Interference displayed on the display or audible noise is heard	Caused by surrounding electrical appliances or fluorescent lights.	Move the display to another location to see if the interference is reduced or connect the display to another power outlet.
Colour is abnormal	The signal cable is not connected properly.	Make sure that the signal cable is attached firmly to the display.
Picture is distorted with abnormal patterns	<ul style="list-style-type: none"> The signal cable is not connected properly. The input signal is beyond the capabilities of the display. 	<ul style="list-style-type: none"> Make sure that the signal cable is attached firmly. Check the video signal source to see if it is beyond the range of the display. Please verify its specifications with this display's specification section.
Display image doesn't fill up the full size of the screen	The picture format is not set correctly.	Open the OSD menu > Screen and try the different formats. Refer to page 54.
Can hear sound, but no picture	Improperly connected source signal cable.	Make sure that both video inputs and sound inputs are correctly connected.
Can see picture but no sound is heard	<ul style="list-style-type: none"> Improperly connected source signal cable. Volume is turned all the way down. Mute function is turned on. No external speaker connected. 	<ul style="list-style-type: none"> Make sure that both video and sound inputs are correctly connected. Press the VOL+ button to hear the sound. Switch the mute function off by pressing the  button on the remote control. Connect the external speakers and adjust the volume to a suitable level.
Some picture elements do not light up	Some pixels of the display may not turn on.	This display is manufactured using an extremely high level of precision technology: however, sometimes some pixels of the display may not display. This is not a malfunction.
After-Images can still be seen on the display after the display is powered off. (Examples of still pictures include logos, video games, computer images, and images displayed in 4:3 normal mode)	A still picture is displayed for an over extended period of time.	Do not allow a still image to be displayed for an extended period of time as this can cause a permanent after-image to remain on the display. Enable OSD menu > Screen > Anti-Burn-in™ function. Refer to page 54.

APPENDIX

Symptom	Possible Cause	Remedy
The response of the system is slow or the system crashes	<ul style="list-style-type: none"> • Too many apps are running in the background. • The normal operation of the system is disturbed by the environmental conditions, for example thunderstorm. 	Disconnect your interactive display from the power outlet and wait for 1-2 minutes. Then reconnect the power cable and restart the display.
The touch response is slow and not functioning	Too many apps are running in the background.	<ul style="list-style-type: none"> • Close the apps that you are not using. Then touch  > Keeper  to clear cache. • Restart the system.
Cannot connect to Wi-Fi	Wi-Fi module is not installed to the interactive display or is not installed correctly.	(Re)install the Wi-Fi module to the interactive display. Refer to page 20.

7.5 Transporting the Interactive Display

To transport the interactive display for repair or shipment, place the display in its original packaging carton.

- 1 Place the interactive display inside the supplied protective bag (a).
- 2 Place the lower foam cushion (b) into the lower box (c).
- 3 Place the interactive display inside the lower foam cushion (a).
- 4 Place the upper foam cushion (d) on top of the interactive display.
- 5 Place the accessories (e) on the designated area inside the lower foam cushion (b) (if necessary).
- 6 Place the upper box (f) on the interactive display.
- 7 Secure the upper box to the lower box.

APPENDIX

IFP-6503

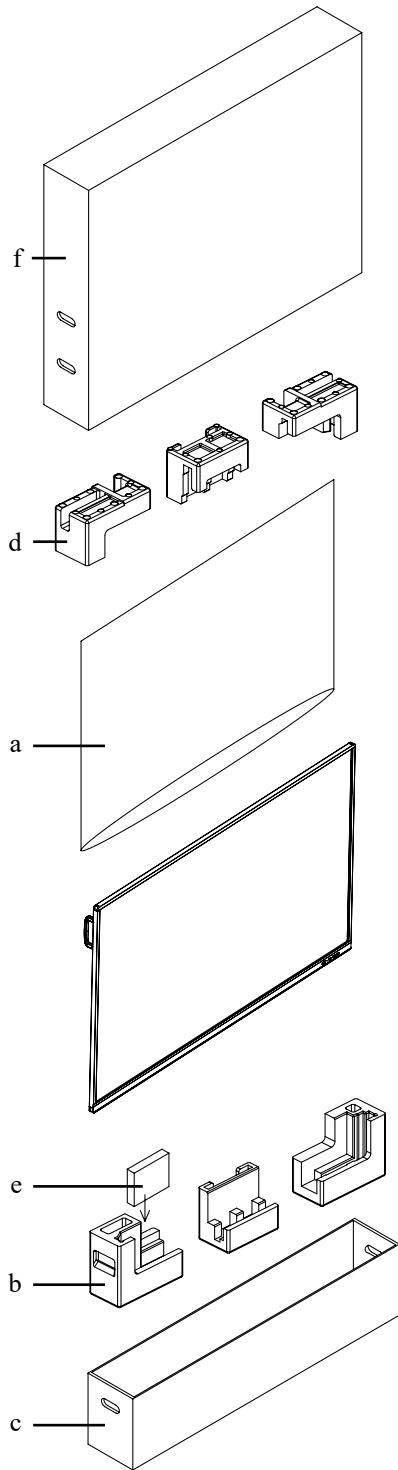

IFP-7503/IFP-8603

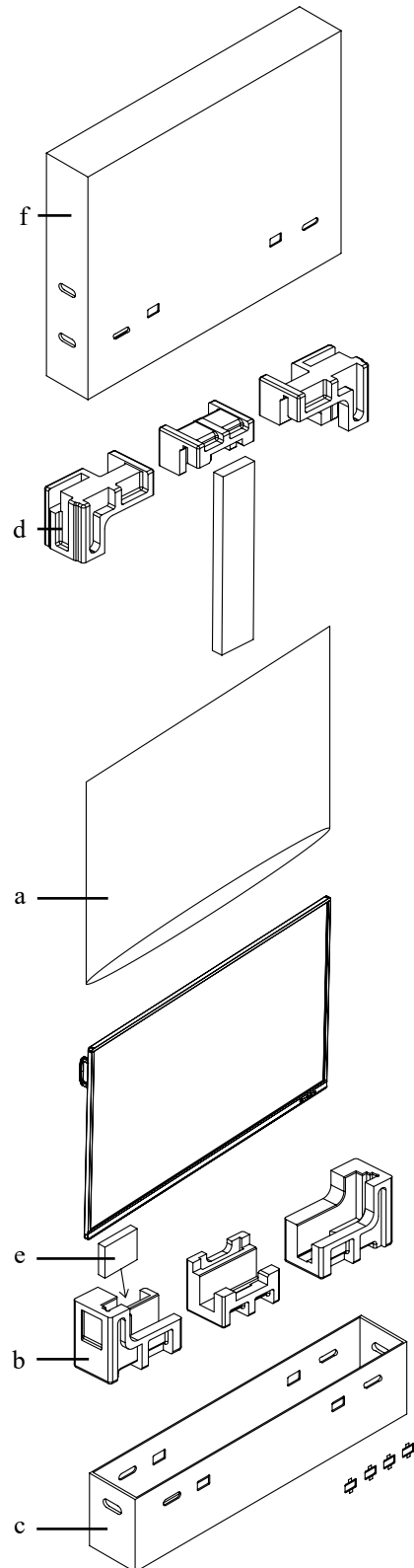

CHAPTER 7: SPECIFICATIONS

7.1 Display Specifications

		IFP-6503	IFP-7503	IFP-8603
Panel	Panel Type	LED-Backlit TFT LCD (IPS Technology)	LED-Backlit TFT LCD (IPS Technology)	LED-Backlit TFT LCD (IPS Technology)
	Panel Size	64.5"	74.5"	85.6"
	Max. Resolution	UHD 3840 x 2160	UHD 3840 x 2160	UHD 3840 x 2160
	Pixel Pitch	0.373 mm	0.430 mm	0.494 mm
	Brightness	350 cd/m ²	350 cd/m ²	350 cd/m ²
	Contrast Ratio	1200:1	1100:1	1200:1
	Viewing Angle (H/V)	178°/178°	178°/178°	178°/178°
	Display Colour	1.07B	1.07B	1.07B
	Response Time	5 ms	5 ms	5 ms
	Surface Treatment	Haze 25%, 3H, Anti-glare treatment	Haze 25%, 2H, Anti-glare treatment	Haze 28%, 2H, Anti-glare treatment
Frequency (H/V)	H Freq.	30 kHz-80 kHz	30 kHz-80 kHz	30 kHz-80 kHz
	V Freq.	50 Hz-76 Hz	50 Hz-76 Hz	50 Hz-76 Hz
Input	HDMI	2.0 x 3	2.0 x 3	2.0 x 3
	VGA	15-Pin D-Sub x 1	15-Pin D-Sub x 1	15-Pin D-Sub x 1
Output	HDMI	2.0 x 1	2.0 x 1	2.0 x 1
External Control	RS232 In	9-Pin D-Sub	9-Pin D-Sub	9-Pin D-Sub
	LAN (RJ45)	RJ45 x 2	RJ45 x 2	RJ45 x 2
Embedded System	OS	Android 9.0	Android 9.0	Android 9.0
	CPU	Dual core A73	Dual core A73	Dual core A73
	Memory	4G	4G	4G
	Storage	32G	32G	32G
Other Connectivity	USB	2.0 x 1 / 3.0 x 4 / Type-C (DP 1.4 / Data 3.0 / PD:65W)	2.0 x 1 / 3.0 x 4 / Type-C (DP 1.4 / Data 3.0 / PD:65W)	2.0 x 1 / 3.0 x 4 / Type-C (DP 1.4 / Data 3.0 / PD:65W)
	OPS Slot	Yes	Yes	Yes
Audio	Audio In	Stereo Audio Jack (3.5 mm)	Stereo Audio Jack (3.5 mm)	Stereo Audio Jack (3.5 mm)
	Audio Out	Stereo Audio Jack (3.5 mm), S/PDIF	Stereo Audio Jack (3.5 mm), S/PDIF	Stereo Audio Jack (3.5 mm), S/PDIF
	Internal Speakers	16W x 2	16W x 2	16W x 2
Touch Screen	Technology	Infrared Touch Frame	Infrared Touch Frame	Infrared Touch Frame
	Positional Accuracy	±1.0 mm	±1.0 mm	±1.5mm
	Panel Interface	USB 2.0 x 2 (Type-B)	USB 2.0 x 2 (Type-B)	USB 2.0 x 2 (Type-B)
	Single-touch Plug & Play	Windows 2000/XP/Vista/CE 6.0 macOS	Windows 2000/XP/Vista/CE 6.0 macOS	Windows 2000/XP/Vista/CE 6.0 macOS
	Multi-touch Plug & Play	Windows 7/8/10/11 Android/Linux (kernel version 3.5+) Chrome OS (39 or above)	Windows 7/8/10/11 Android/Linux (kernel version 3.5+) Chrome OS (39 or above)	Windows 7/8/10/11 Android/Linux (kernel version 3.5+) Chrome OS (39 or above)
	Multi-touch Support by Driver	macOS (supported by UPDD driver)	macOS (supported by UPDD driver)	macOS (supported by UPDD driver)
Power	Power Requirements	AC 100-240V, 50/60 Hz	AC 100-240V, 50/60 Hz	AC 100-240V, 50/60 Hz
	On Mode	175W	192W	448W
	Standby Mode	< 0.5W	< 0.5W	< 0.5W
	Off Mode	0W	0W	0W
	Power Supply	Internal	Internal	Internal
Glass	Thickness	3.2 mm (0.13")	3.2 mm (0.13")	3.2 mm (0.13")
	Transmission Rate	≥ 88%	≥ 88%	≥ 88%
	Hardness	≥ 8H	≥ 8H	≥ 8H
	Gloss	75±5 GU	75±5 GU	75±5 GU
Operating Conditions	Temperature	0°C-40°C (32°F-104°F)	0°C-40°C (32°F-104°F)	0°C-40°C (32°F-104°F)
	Humidity	10%-90% (non-condensing)	10%-90% (non-condensing)	10%-90% (non-condensing)
Storage Conditions	Temperature	-20°C-60°C (-4°F-140°F)	-20°C-60°C (-4°F-140°F)	-20°C-60°C (-4°F-140°F)
	Humidity	10%-90% (non-condensing)	10%-90% (non-condensing)	10%-90% (non-condensing)
Mounting	VESA FPMPMI	Yes (600 x 400 mm)	Yes (800 x 400 mm)	Yes (800 x 600 mm)

SPECIFICATIONS

		IFP-6503	IFP-7503	IFP-8603
Dimensions	with Bracket (W x H x D)	1488.4 x 896.6 x 108.4 mm (58.6" x35.3" x4.3")	1709.4 x 1019.9 x 107.7 mm (67.3" x40.2" x4.2")	1957.0 x 1159.7 x 107.6 mm (77.1" x45.7" x4.2")
	Packaging (W x H x D)	1628.0 x 1050.0 x 208.0 mm (64.1" x41.3" x8.2")	1863.0 x 1140.0 x 225.0 mm (73.4" x44.9" x8.9")	2110.0 x 1283.0 x 225.0 mm (83.1" x50.5" x8.9")
Weight	w/o Bracket	38.0 kg (83.8 lb)	49.5 kg (109.1 lb)	64.6 kg (142.4 lb)
	with Bracket	39.4 kg (86.9 lb)	50.9 kg (112.2 lb)	66.0 kg (145.5 lb)
	Packaging	49.0 kg (108.0 lb)	63.9 kg (140.9 lb)	82.9 kg (182.8 lb)

Note:

- ◆ All specifications are subject to change without prior notice.

7.2 Display Dimensions

IFP-6503

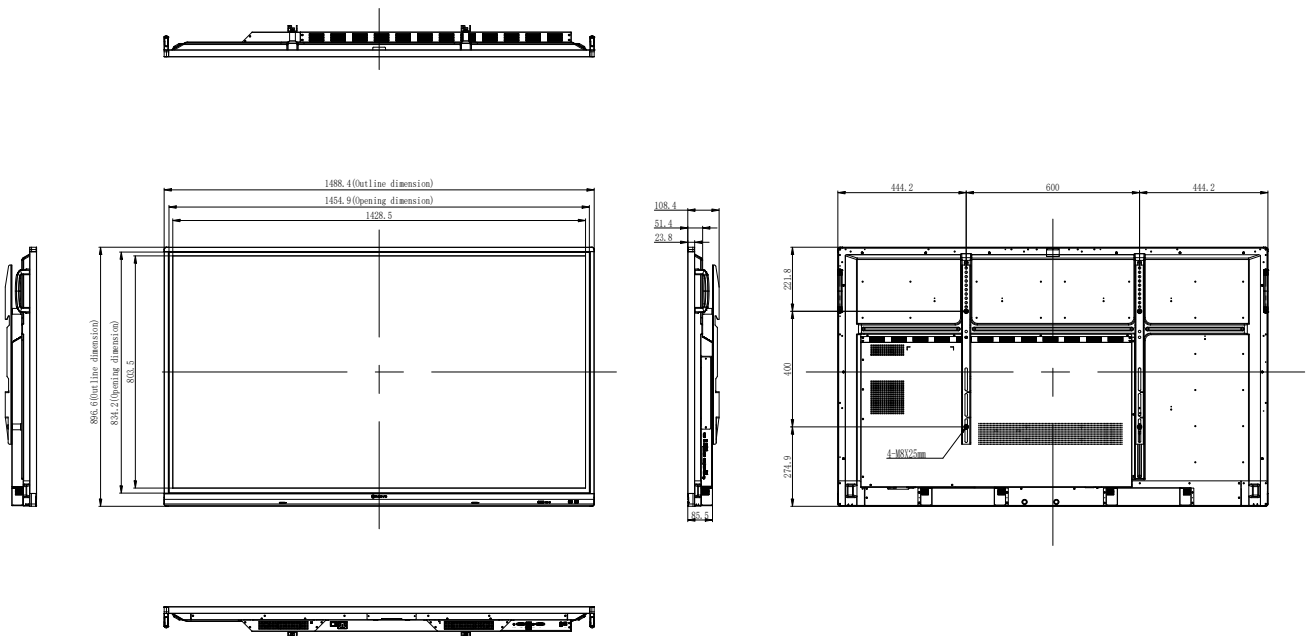

SPECIFICATIONS

IFP-7503

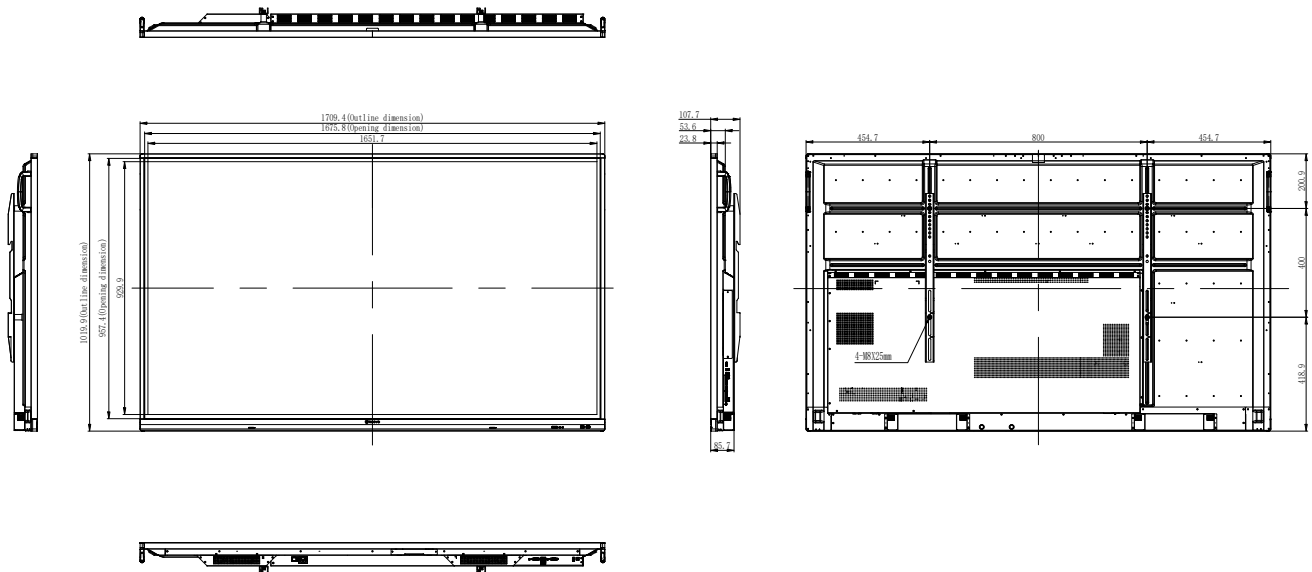

IFP-8603

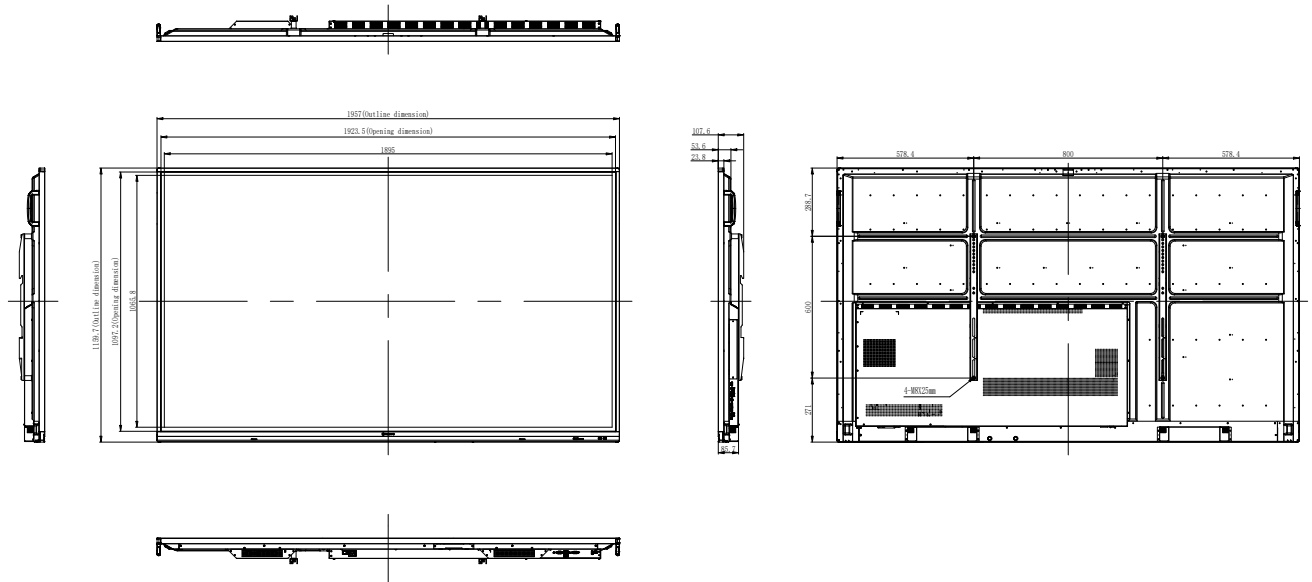

AG Neovo

Company Address: 5F-1, No. 3-1, Park Street, Nangang District, Taipei, 11503, Taiwan.

Copyright © 2022 AG Neovo. All rights reserved.

IF6530/ IF7530/ IF8630_UM_V012